

A Policy Statement for Scotland

# designing streets

## Policies

- ▶ Street design must consider place before movement.
- ▶ Street design guidance, as set out in this document, can be a material consideration in determining planning applications and appeals.
- ▶ Street design should meet the six qualities of successful places, as set out in *Designing Places*.
- ▶ Street design should be based on balanced decision-making and must adopt a multidisciplinary collaborative approach.
- ▶ Street design should run planning permission and Road Construction Consent (RCC) processes in parallel.

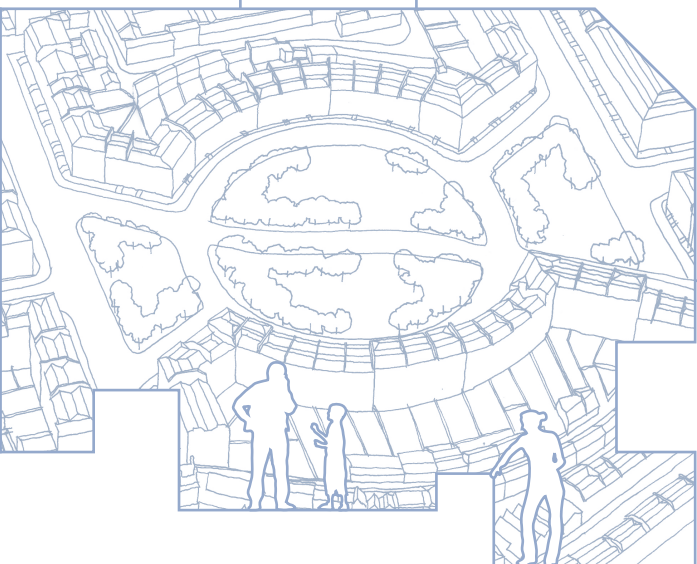

The Scottish Government



## Contents

### 1 Foreword

John Swinney MSP  
Cabinet Secretary for Finance  
and Sustainable Growth

### 3 Introduction

Status and aims of *Designing Streets*  
The value of good street design  
Policy relationship  
Who is *Designing Streets* for?  
Development of the document  
Streets and roads  
The relationship of *Designing Streets*  
to main and busy streets

### 5 How to use this document

- 7 Part 1: **General**: Creating streets and places  
11 Part 2: **Detail**: Getting the design right  
55 Part 3: **Process**: How to achieve better outcomes

### 59 Conclusion

### 60 Annex: Technical questions and answers

What is the legal and technical context?  
What is the risk and liability?  
What are the issues regarding disability  
discrimination?  
What are the adoption and maintenance issues?

### 64 References



© Crown copyright 2010  
ISBN: 978-0-7559-8264-6

The Scottish Government  
St Andrew's House  
Edinburgh  
EH1 3DG

Produced for the Scottish Government by  
RR Donnelley B63780 3/10



## Foreword

Scotland's best streets provide some of the most valuable social spaces that we possess. The process of street design offers an opportunity to deliver far more to our society than simply transport corridors. Well-designed streets can be a vital resource in social, economic and cultural terms; they can be the main component of our public realm and a core element of local and national identity. Well-designed streets can also be crucial components in Scotland's drive towards sustainable development and responding to climate change. Attractive and well-connected street networks encourage more people to walk and cycle to local destinations, improving their health while reducing motor traffic, energy use and pollution.

Historically, Scotland has produced a wealth of unique and distinctive streets, squares, mews and lanes, and I believe that there is a great deal that can be learned from our past successes in this regard. *Designing Streets* is now positioned at the heart of planning, transport and architecture policy. This document underpins Scottish Ministers' resolve to move away from a prescriptive, standards-based approach in order to return to one which better enables designers and local authorities to unlock the full potential of our streets to become vibrant, safe and attractive places.

I welcome *Designing Streets* as a new policy document which puts place and people before the movement of motor vehicles. The Scottish Government is committed to an agenda of sustainable development that focuses on the creation of quality places and Scottish Ministers believe that good street design is of critical importance in this effort. This policy statement represents a step change in established practices and, given the direct influence that streets can have on our lives and environment, I believe it to be an essential change.

John Swinney MSP  
Cabinet Secretary for Finance and Sustainable Growth

place  
before movement



# Introduction





## Status and aims of *Designing Streets*

This document is the first policy statement in Scotland for street design.

The premise upon which the document is based is that good street design should derive from an intelligent response to location, rather than the rigid application of standards, regardless of context. *Designing Streets* does not, thus, support a standards-based methodology for street design but instead requires a design-led approach. This demands taking into account site-specific requirements and involves early engagement with all relevant parties. *Designing Streets* marks the Scottish Government's commitment to move away from processes which tend to result in streets with a poor sense of place and to change the emphasis of policy requirements to raise the quality of design in urban and rural development.

### The value of good street design

Streets exert an immense influence upon our lifestyles and behaviour. Street design also has a direct influence on significant issues such as climate change, public health, social justice, inclusivity and local and district economies. *Designing Streets* recognises these pressures and seeks to build a collective response through the design of new streets and the regeneration of existing streets that is informed by as wide a range of issues and stakeholders as possible. Through the introduction of this policy, the Scottish Government seeks to ensure that specific interests are no longer promoted without an appreciation of the wider context. Collaboration and awareness between what have often previously existed as singular processes is vital if the aims of *Designing Streets* are to be met.

Designing Streets is **not a standards-based document**. Balanced decision-making **is at the core** of this policy. **Design-led solutions** must be employed.

### Policy relationship

This document sits alongside *Designing Places*<sup>1</sup>, which sets out government aspirations for design and the role of the planning system in delivering these. Together, they are the Scottish Government's two key policy statements on design and place-making. Both documents are national planning policy and are supported by a range of design-based Planning Advice Notes (PANs).

*Designing Streets* updates and replaces *PAN 76 New Residential Streets*<sup>2</sup> (which is now withdrawn) and, in doing so, marks a distinct shift, raising the importance of street design issues from the subject of advice to that of policy. In addition, all previous road guidance and standards documents based on *DB32*<sup>3</sup> principles are superseded by *Designing Streets*. Many local authorities in Scotland have developed their own street design guidance and there is still an important role for local guidance to ensure that street design responds to local context. These existing documents may contain information on construction details and local palettes of materials which is still relevant, however information on principles, layout and street geometry which is not consistent with *Designing Streets* should be revised. *Designing Streets* should be adopted by all Scottish local authorities or should provide the basis for local and site-specific policy and guidance.



## Who is *Designing Streets* for?

*Designing Streets* is aimed at everyone who plays a part in creating or determining the quality of streets; architects, engineers, planners, developers, politicians, local authorities and, indeed, anyone who has an interest in how street design is taken forward. It is important that professionals understand all of the key issues and do not restrict their interest to any one particular area.

*Designing Streets* is expected to be used predominantly for the design, construction, adoption and maintenance of new streets, but it is also applicable to existing streets subject to re-design.

## Development of the document

*Designing Streets* was developed for the Scottish Government by a multi-disciplinary team of roads and transportation engineers, urban designers, planners and legal advisors, led by WSP UK. The document has been informed by case studies and best practice, and was subject to significant stakeholder consultation. It derives, in essence, from *Manual for Streets*<sup>4</sup>, which was produced for the Department for Transport, the Welsh Assembly Government and Communities and Local Government. *Manual for Streets* is evidence-based guidance which focuses on lightly trafficked residential streets and cited and commissioned detailed research. *Designing Streets* has been tailored to meet Scotland's needs and, as a policy document, does not reproduce this evidence in detail.

## Streets and roads

Streets have to fulfil a complex variety of functions in order to meet people's needs as places in which to live, to work and to move around. Their design requires a thoughtful approach that balances potential conflicts between different users and objectives. A clear distinction can be drawn in functional terms between roads and streets as follows:

- ▶ Roads are thoroughfares whose main function is to facilitate the movement of motor traffic.
- ▶ Streets have important public realm functions beyond those related to motor traffic. They are typically lined with buildings and public spaces and, whilst facilitation of movement is still a key function, they normally support a range of social, leisure, retail and commercial functions.

All thoroughfares within urban settings and rural boundaries should normally be treated as streets.

Reference should no longer be made to road hierarchies based on terminology such as local distributor/local access roads.

## The relationship of *Designing Streets* to main and busy streets

*Designing Streets* provides policy that should be followed in designing and approving all streets. Whilst its technical advice is aimed particularly at residential and lightly trafficked streets, many of the key principles are also applicable to other types of street, for example rural and high streets. When considering busier streets, the movement function of the street may well become more significant or complex but this should be resolved through an integrated design approach and should not compromise the quality or the sense of place.

*Design Manual for Roads and Bridges (DMRB)*<sup>5</sup> is the standard for the design, maintenance and improvement of trunk roads and motorways. There are some locations, however, where a more sensitive design that follows the principles of *Designing Streets* may well be appropriate, such as where a small burgh High Street is also a trunk road.

Most importantly, a multi-disciplinary approach, full community engagement and a balanced appreciation of context and function is fundamental to successful outcomes in such cases.

The diagram below shows where streets and roads exist and where they often meet.

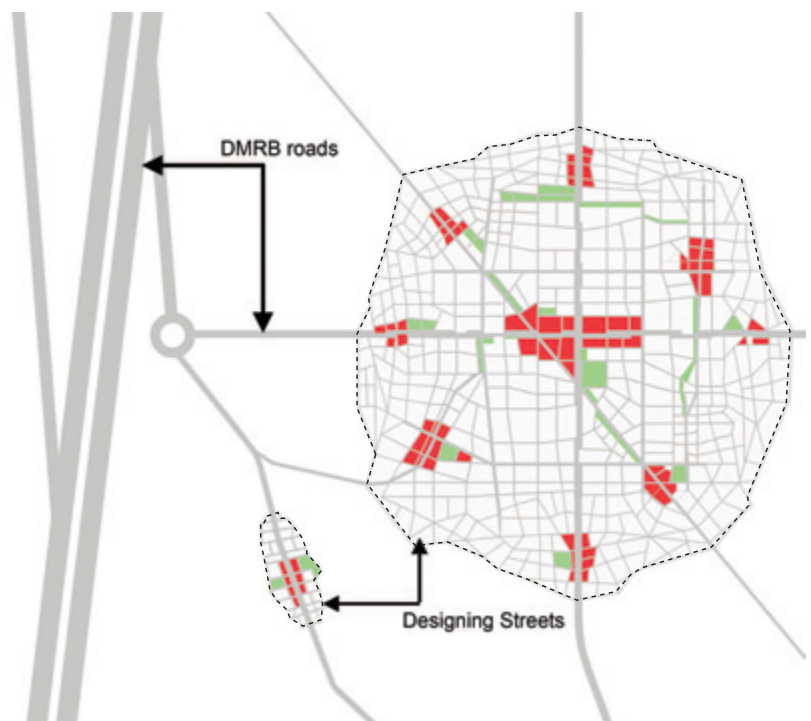

*Designing Streets* policy and guidance should be applied within all urban and rural boundaries

## How to use this document

*Designing Streets* is split into three parts plus an annex:

- ▣ **Part 1: General** – Creating streets and places
- ▣ **Part 2: Detail** – Getting the design right
- ▣ **Part 3: Process** – How to achieve better outcomes

The document begins with an overview of creating places, with street design as a key consideration. It then looks at the detail of how to approach the creation of well-designed streets. This is followed by a description of processes which should be followed in order to achieve the best outcomes. Within each part, the policies are highlighted, and then supported by background information.

**The Annex** provides a series of questions and answers on some of the more technical issues.

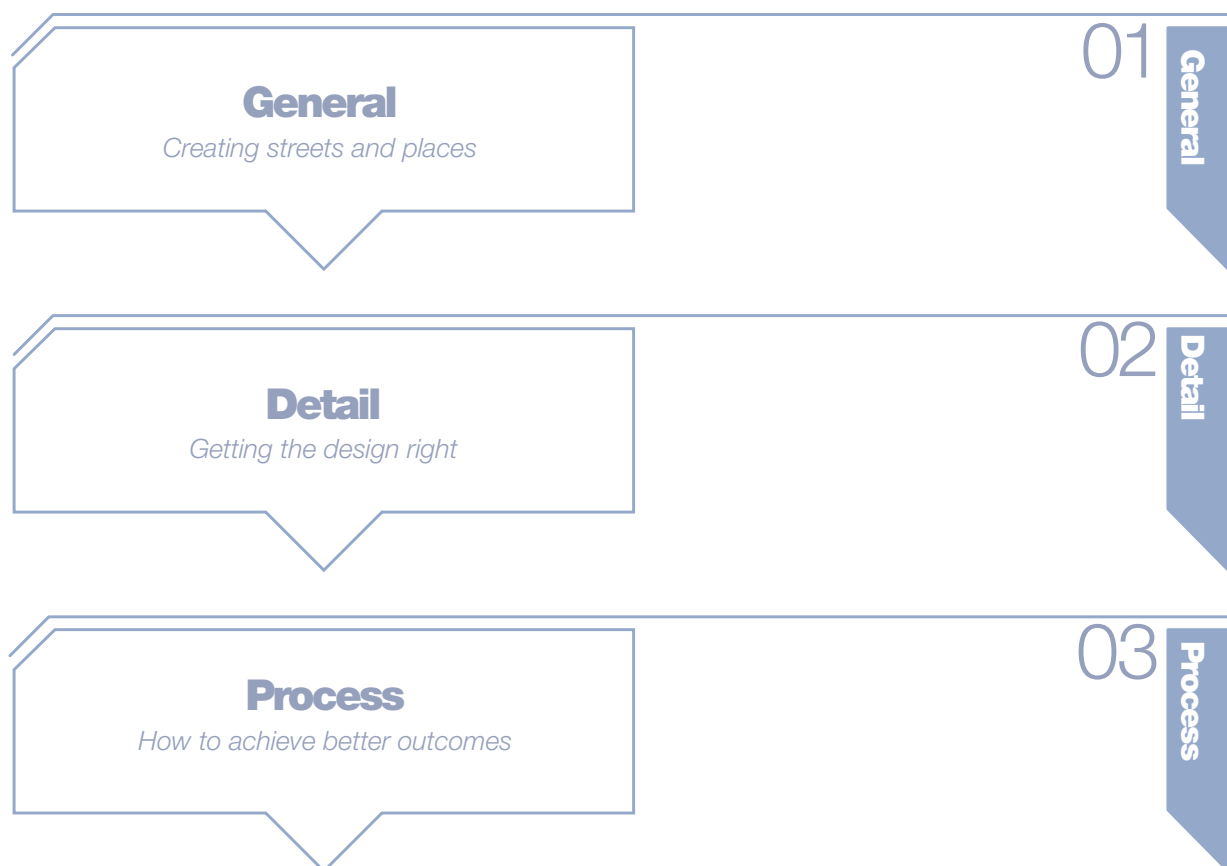



# Creating streets and places





## Creating streets and places

Good street design can promote a better quality of living for everyone. Sustainable patterns of behaviour can be influenced greatly by the intelligent design of streets. It is therefore essential that all parties involved in street design ensure that streets contribute as positively to their environment as is possible.

Creating good streets is not principally about creating successful traffic movement: it is about creating successful places.

# policies

- ▶ **Street design must consider place before movement**
- ▶ **Street design guidance, as set out in this document, can be a material consideration in determining planning applications and appeals**

Streets have two key functions: **place** and **movement**.

In the more recent past, vehicle movement has often dominated the design of streets, resulting in many streets being out of context with their location and overly influenced by prescriptive standards. The prime concern of *Designing Streets*, in contrast, is to reverse this trend and shift the focus firmly back to the creation of successful places through good street design.

### A 'sense of place'

A sense of place can be considered as the character or atmosphere of a place and the connection felt by people with that place. A positive sense of place is fundamental to a richer and more fulfilling environment. It comes largely from creating a strong relationship between the street and the buildings and spaces that frame it. A positive sense of place encompasses a number of aspects, most notably the street's:

- ▶ local distinctiveness;
- ▶ visual quality; and
- ▶ potential to encourage social and economic activity.

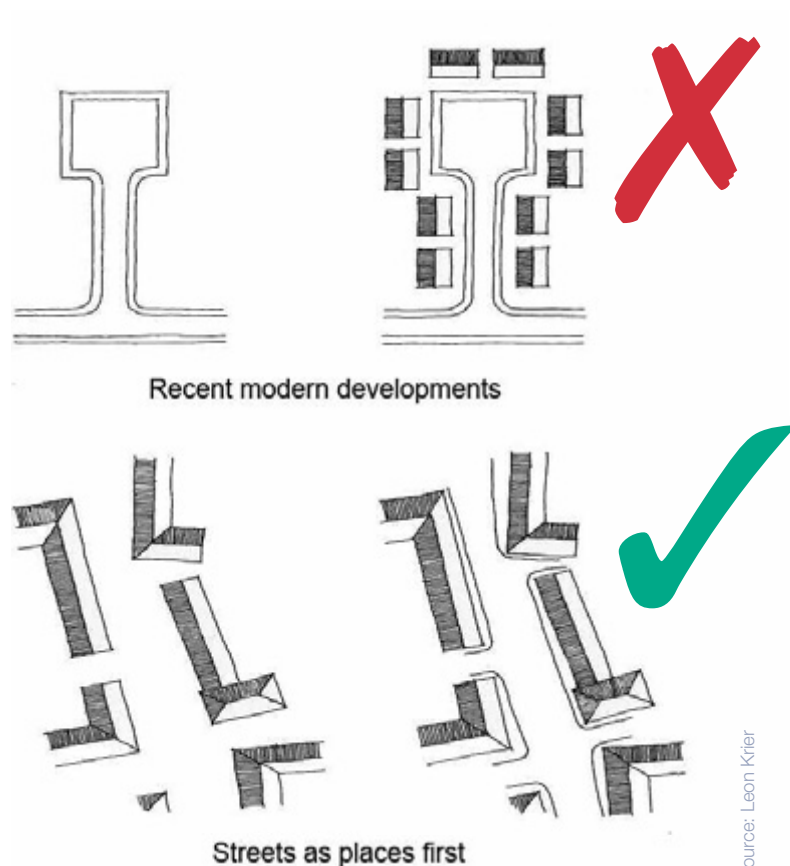

Consider the place before vehicle movement

## Movement

Providing for movement along a street is vital, but it should not be considered independently of the street's other functions. The need to cater for motor vehicles is well understood by designers, but the passage of people on foot and cycle has often been neglected. Walking and cycling are important modes of travel, offering a more sustainable alternative to the car, making a positive contribution to the overall character of a place, public health, social interaction and to tackling climate change through reductions in carbon emissions.

### Achieving the right balance between place and movement

Streets should no longer be designed by assuming 'place' to be automatically subservient to 'movement'.

Good street design demands that issues of place and movement are considered together. The status of a street is dependent on its relative importance within a network in terms of both these considerations, and its status should commonly determine the design approach taken. It is only by considering both functions that the right balance will be achieved, but the focus of street design should be on creating a positive sense of place that is supported by an appropriate movement pattern. Other than in the design of motorways and some other inter-urban roads, it is seldom appropriate to focus solely on either place or movement functions, even in streets carrying heavier volumes of traffic, such as high streets.

**Place status** denotes the relative significance of a street, junction or section of a street in human terms. The most important places will usually be near the centre of any settlement or built-up area, but important places will also exist along arterial routes, in district centres, local centres and within neighbourhoods.

In new developments, locations with a relatively high place function would be those where people are likely to gather and interact with each other, such as outside schools, in local town and district centres or near parades of shops. Streets that pass through these areas need to reflect the importance of these places in their design, which in new developments should be identified at the masterplan/scheme design stage.

**Movement status** can be expressed in terms of traffic volume and the importance of the street, or section of street, within a network. Movement status should be considered in terms of all modes of movement, including vehicle traffic, pedestrian and cycle flows and public transport. Movement status can vary along the length of a route. Another way of assessing the movement status of a street is to consider the geographical scale of the destinations it serves. Here, movement status can range from national networks (including motorways) through to city, town, district, neighbourhood and local networks, where the movement function of motor vehicles is slightly lower.

place  
comes first



## Place and movement matrix

Defining the relative importance of particular streets/roads in terms of place and movement functions should inform subsequent design choices. For example:

- ▶ motorways – high movement function, low place function;
- ▶ high streets – medium movement function, high place function; and
- ▶ residential streets – low to medium movement function, medium to high place function.

This way of looking at streets can be expressed as a two-dimensional matrix (right) where the axes are defined in terms of place and movement. Areas where people are likely to gather and interact with each other will have a high place function.

The matrix recognises that, whilst some streets are more important than others in terms of traffic flow, some are also more important than others in terms of their place function and deserve to be treated differently. This approach allows designers to break away from previous approaches to hierarchy, whereby street designs were only based on traffic considerations.

Once the relative significance of the movement and place functions has been established, it is possible to set objectives for particular parts of a network. This will allow the local authority to select appropriate design criteria for creating new links or for changing existing ones.

Movement and place considerations are important in determining the appropriate design speeds, speed limits and urban structure, along with the level of adjacent development and traffic composition.

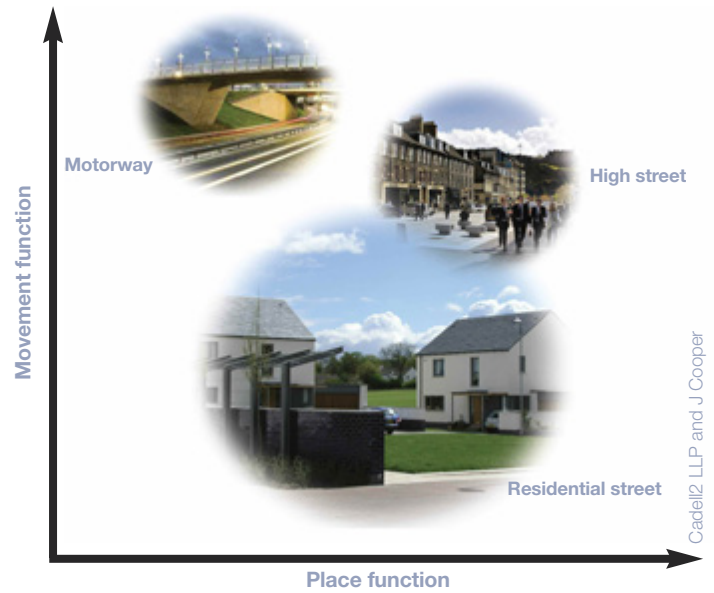

## Street design guidance, as set out in this document, can be a **material consideration** in determining planning applications and appeals

Planning Permission may be refused and the refusal defended at appeal or local review *solely* on design grounds.

*Designing Streets* is national planning policy and its policies should be taken into account by local authorities when determining planning applications and producing guidance. *Designing Places* and *Designing Streets* stand together as the two key design policy statements for Scotland.

# Getting the design right





### Getting the design right

The issues around good street design are highly dependent on context and may vary considerably in their nature and complexity from one circumstance to another. However, an approach which is underpinned by a consideration of the six qualities of successful places set out in *Designing Places* has clear benefits as a methodology to ensure that key issues are addressed. This policy statement elaborates on issues of street design in relation to these qualities and also describes an approach to the development of well-designed streets from large-scale to detailed considerations.

## policy

- ▣ **Street design should meet the six qualities of successful places, as set out in *Designing Places***

- Distinctive
- Safe & pleasant
- Easy to move around
- Welcoming
- Adaptable
- Resource efficient

These six qualities provide a framework which should be used when considering street design. To help show how they relate to each other, the table on the following pages identifies some of the key considerations which relate to 'quality'. This information is then further supported by more detailed technical information on how to create good street design.

# The six qualities of successful places: Key considerations for street design

## *distinctive*

*Street design should respond to local context to deliver places that are distinctive*

### **Block structure**

- ▶ The urban form should be distinctive with landmarks and vistas that provide good orientation and navigation of an area

### **Context and character**

- ▶ The requirements and impact of pedestrians, cycles and vehicles should be reconciled with local context to create streets with distinctive character
- ▶ Opportunities should be taken to respond to, and to derive value from, relevant elements of the historic environment in creating places of distinctive character

## *safe & pleasant*

*Streets should be designed to be safe and attractive places*

### **Pedestrians and cyclists**

- ▶ Street user hierarchy should consider pedestrians first and private motor vehicles last
- ▶ Street design should be inclusive, providing for all people regardless of age or ability

### **Achieving appropriate traffic speed**

- ▶ Design should be used to influence driver behaviour to reduce vehicle speed to levels that are appropriate for the local context and deliver safe streets for all

### **Reducing clutter**

- ▶ Signs and street markings should be kept to a minimum and considered early in the design process
- ▶ Street lighting should be as discreet as possible, but provide adequate illumination
- ▶ Street furniture should be located for maximum benefit and to reduce pedestrian obstruction

## *easy to move around*

*Streets should be easy to move around for all users and connect well to existing movement networks*

### **Connections within a place**

- ▶ Street design should provide good connectivity for all modes of movement and for all groups of street users respecting diversity and inclusion

### **Public transport**

- ▶ Public transport planning should be considered at an early stage in the design process

### **Junction types and arrangements**

- ▶ Junctions should be designed with the considerations of the needs of pedestrians first
- ▶ Junctions should be designed to suit context and urban form – standardised forms should not dictate the street pattern



## welcoming

*Street layout and detail should encourage positive interaction for all members of the community*

### Walkable neighbourhoods

- ▶ Street layouts should be configured to allow walkable access to local amenities for all street users

### Streets for people

- ▶ Streets should allow for and encourage social interaction

## adaptable

*Street networks should be designed to accommodate future adaptation*

### Connections to wider networks

- ▶ Street patterns should be fully integrated with surrounding networks to provide flexibility and accommodate changes in built and social environments

### Integrating parking

- ▶ Parking should be accommodated by a variety of means to provide flexibility and lessen visual impact

### Service and emergency vehicles

- ▶ Street layouts should accommodate emergency and service vehicles without compromising a positive sense of place

## resource efficient

*Street design should consider orientation, the integration of sustainable drainage and use attractive, durable materials that can be easily maintained*

### Orientation

- ▶ Orientation of buildings, streets and open space should maximise environmental benefits

### Drainage

- ▶ Streets should use appropriate SUDS techniques as relevant to the context in order to minimise environmental impacts

### Utilities

- ▶ The accommodation of services should not determine the layout of streets or footways

### Planting

- ▶ Street design should aim to integrate natural landscape features and foster positive biodiversity

### Materials

- ▶ Materials should be distinctive, easily maintained, provide durability and be of a standard and quality to appeal visually within the specific context

When designing streets, it is important to consider the relevant issues in a hierarchical way, working from issues of structure through to layout and geometry and on to matters of detail. The guidance in *Designing Streets* is structured in this way to help inform the understanding and approach of those involved in street design.

Guidance in support of the considerations in the preceding table is now ordered hierarchically, providing information on street design from macro to micro scales. The hierarchy is a guide to understanding and addressing relevant issues, however there will be overlaps between issues dependant on specific circumstances.

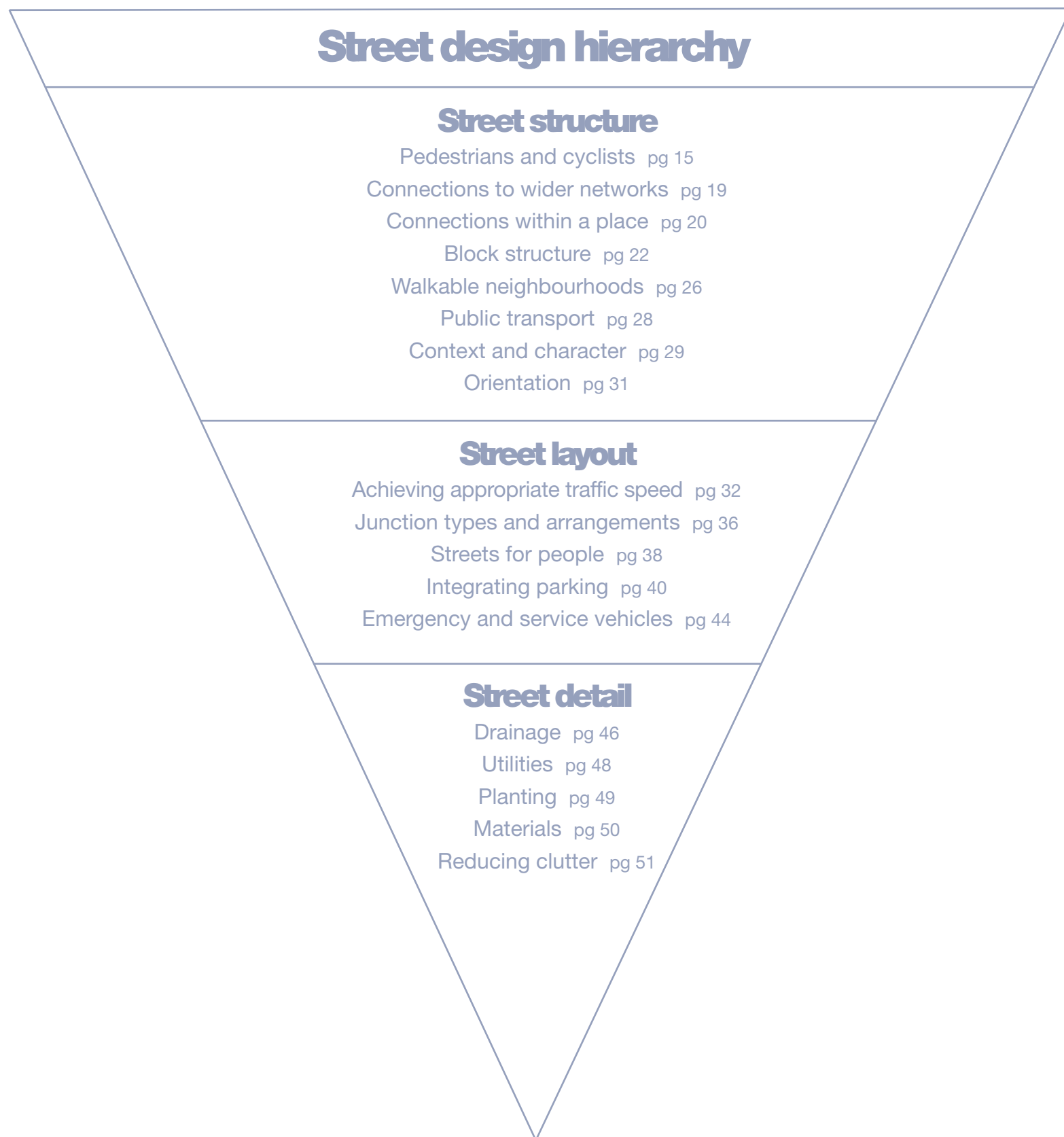



# Street structure

## Pedestrians and cyclists

### Key considerations

- ▣ Street user hierarchy should consider pedestrians first and private motor vehicles last
- ▣ Street design should be inclusive, providing for all people regardless of age or ability

### Pedestrians

Walking is the most sustainable form of transport. Streets should be designed, not only to allow for walking, but to actively encourage it to take place. The propensity to walk is influenced not only by distance, but also by the quality of the walking experience. All streets should offer a pleasant walking experience. Sightlines and visibility towards destinations or intermediate points are important for navigating and personal security, and they can help people with cognitive impairment. Pedestrians may be walking with purpose or engaging in other activities such as play, socialising, shopping or just sitting. The issues for street design in relation to these activities are explored later in the document.



Gillespies

Within the context of *Designing Streets*, pedestrians include wheelchair users, mobility scooter users and people pushing wheeled equipment such as prams.

### Pedestrian movement

The layout of our towns and cities historically suited pedestrian movement though, over time, motor vehicles have come to dominate our streets. A return to the prioritisation of pedestrian movement over vehicle movement has implications for the design of crossings and street interfaces.



**Edinburgh New Town**

The block dimensions are of a scale that encourages walking

Surface level crossings can be of a number of types, as outlined below:

- ▶ **Uncontrolled crossings** – should have dropped kerbs.
- ▶ **Informal crossings** – can be created through careful use of paving materials and street furniture to indicate a crossing place which encourages slow-moving traffic to give way to pedestrians.
- ▶ **Formal crossings** – of which the *Zebra* crossing type involves the minimum delay for pedestrians when used in the right situation. There are four types of Signalised crossings – *Pelican*, *Puffin*, *Toucan* and *Equestrian* crossings. *Puffin* crossings have a variable crossing time; they use pedestrian detectors to match the length of the crossing period to the time pedestrians take to cross. *Toucan* and *Equestrian* crossings operate in a similar manner to *Puffin* crossings except that cyclists can also use *Toucan* crossings, while *Equestrian* crossings have a separate crossing for horse riders. *Equestrian* crossings can also be combined with cycle and pedestrian facilities. Signalised crossings are preferred by the older people and people with visual and mobility impairments.

There are a number of general principles which should be observed in the design of crossing places as follows:

- ▶ Consideration should be given to the raising of crossings, of whichever type to footway height where possible. Footway surfacing of contrasting colour should be used to demonstrate pedestrian priority and tactile paving should be used to indicate the change in condition to visually impaired pedestrians.
- ▶ Pedestrian refuges and kerb build-outs, used separately, or in combination, effectively narrow the carriageway and so reduce the crossing distance.
- ▶ Footbridges and subways should be avoided; they are usually unsuccessful and create hostile environments – the ground level should be prioritised for pedestrians.
- ▶ Pedestrian desire lines should be kept as straight as possible at side-street junctions. Small corner radii minimise the need for pedestrians to deviate from their desire line.

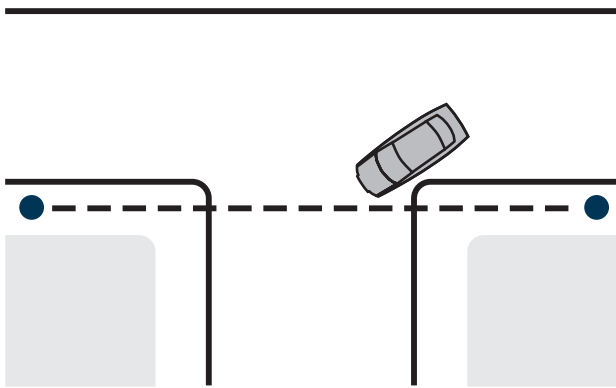

- ▶ Pedestrian desire line (---) is maintained
- ▶ Vehicles turn slowly (10-15 mph)

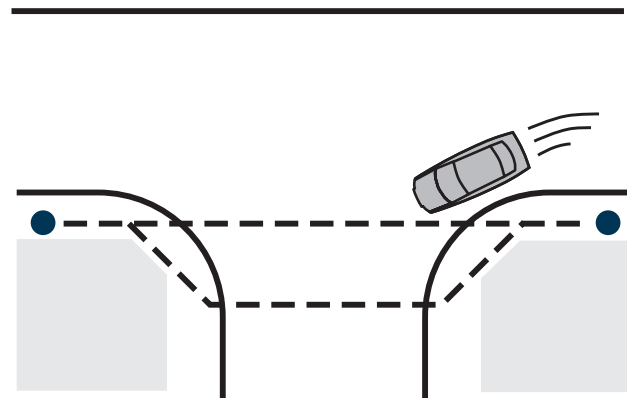

- ▶ Pedestrian desire line deflected
- ▶ Detour required to minimise crossing distance
- ▶ Vehicles turn faster (20-30 mph)

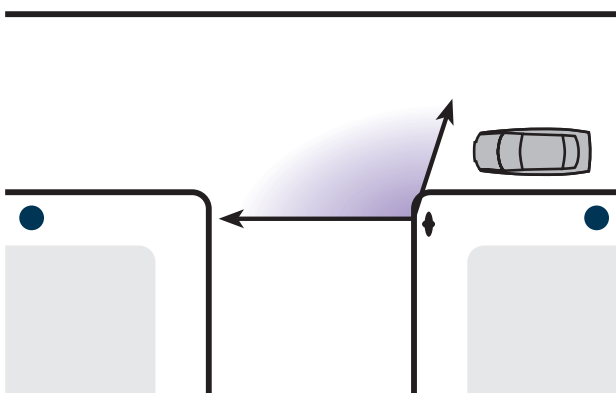

- ▶ Pedestrian does not have to look further behind to check for turning vehicles
- ▶ Pedestrian can easily establish priority because vehicles turn slowly

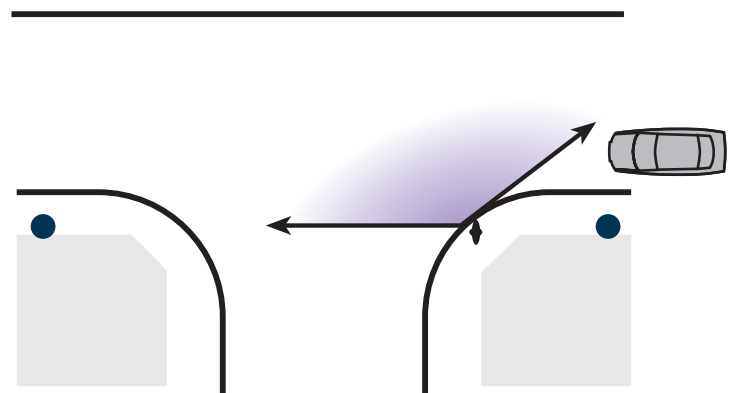

- ▶ Pedestrian must look further behind to check for fast turning vehicles
- ▶ Pedestrian cannot normally establish priority against fast turning vehicles

The effects of corner radii on pedestrians



With small corner radii, large vehicles may need to use the full carriageway width to turn. Swept-path analysis can be used to determine the minimum dimensions required. The footway may need to be strengthened locally in order to allow for larger vehicles occasionally overrunning the corner.

The approach to footways and pedestrian movement should be design-led. Any footway should be fit for purpose, but should give primary importance to delivering positive, attractive spaces. There is no maximum width for footways. In lightly-used streets (such as those with a purely residential function), the unobstructed width for pedestrians should generally be 1.5 – 2 m, however this can be varied to accommodate character and practical requirements. Additional width should be considered between the footway and a heavily used carriageway, or adjacent to gathering places, such as schools and shops.

Porch roofs, awnings, garage doors, bay windows, balconies or other building elements should allow for clear movement of pedestrians underneath.

Designers should attempt to keep pedestrian (and cycle) routes as near to level as possible along their length and width, within the constraints of the site. Longitudinal gradients should ideally be no more than 5%, although topography or other circumstances may require steeper gradients.



Andrew Cameron WSP

Raised crossover, but located away from the desire line for pedestrians and therefore ignored – the crossover should be nearer the junction with, in this case, a steeper ramp for vehicles entering the side street

This can cause particular difficulty for pedestrians with mobility or visual impairments



John Thompson & Partners, Queen Elizabeth Park

Inviting pedestrian link



## Cyclists

Cyclists should generally be accommodated on the carriageway. Only where traffic volumes and speeds are high should the need for a cycle lane be considered.

Cyclists are more likely to choose routes that enable them to keep moving. Routes that take cyclists away from their desire lines and require them to concede priority to side-street traffic are less likely to be used. Designs should contain direct, barrier-free routes for cyclists.

The design of junctions affects the way motorists interact with cyclists. It is recommended that junctions are designed to promote slow motor-vehicle speeds. This may include short corner radii as well as vertical deflections.

- ▶ Cycle tracks are more suited to leisure routes over relatively open spaces. In a built-up area, they should be well overlooked.
- ▶ The headroom over routes used by cyclists should normally be 2.7 m (minimum 2.4 m). The maximum gradients should generally be no more than 3%, or 5% maximum over a distance of 100 m or less, and 7% maximum over a distance of 30 m or less. However, topography may dictate the gradients, particularly if the route is in the carriageway. A cycle route with a steep gradient may be better than none at all.

*Cycling by Design 2010*, alongside the *Cycling Action Plan for Scotland*, is due for publication in April 2010 and will be available at [www.transportscotland.gov.uk](http://www.transportscotland.gov.uk).

*Local Transport Note 2/08 Cycle Infrastructure Design*<sup>6</sup> contain further details on designing for cycles.

### Inclusive design

Inclusive design should be a first principle in street design. The *Disability Discrimination Act 2005*<sup>7</sup> makes it unlawful for a public authority, without justification, to discriminate against a disabled person when exercising its functions.

*PAN 78, Inclusive Design*<sup>8</sup>, contains information on inclusion and the roles and responsibilities of those involved in the built environment. An inclusive environment is one which can be used by everyone, regardless of age, gender, ethnicity or disability.

Issues around disability and age are especially relevant to those involved in the design of the external environment. Particular effort should be made to engage with representatives from these groups and consider specific requirements when developing street design. This should be undertaken at an early stage in the design process.

The requirements upon designers and decision makers regarding mobility equality are discussed later in this document in the Annex.

The Department for Transport document, *Inclusive Mobility*<sup>9</sup> provides detailed information on inclusive design. The Transport Scotland document, *Disability Discrimination Act: Good Practice Guide for Roads*<sup>10</sup> contains information on inclusive design in the construction, operation and maintenance of road infrastructure.



John Thompson & Partners

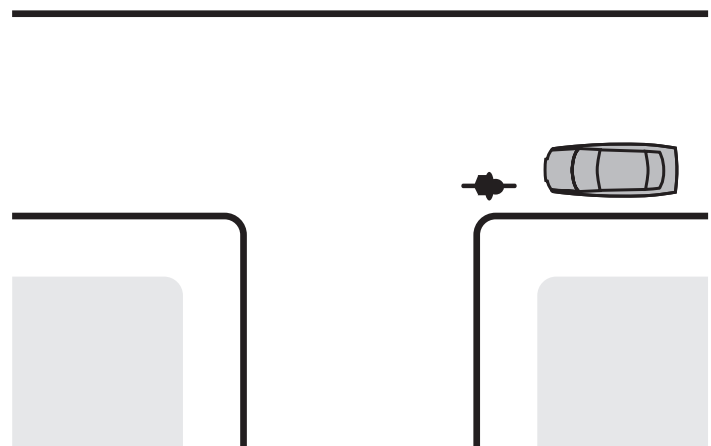

▶ Cycle and car speeds compatible

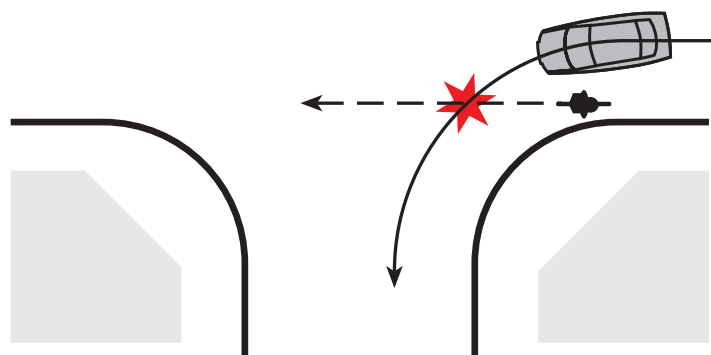

▶ Danger from fast-turning vehicles cutting across cyclists

The effect of corner radii on cyclists near turning vehicles

Devon County Council

## Connections to wider networks

### Key consideration

- Street patterns should be fully integrated with surrounding networks to provide flexibility and accommodate changes in built and social environments

### Connecting layouts to their surroundings

Street networks should, in general, be connected. Connected or 'permeable' networks encourage walking and cycling, and make navigation through places easier. They also lead to a more even spread of motor traffic throughout an area and so avoid the need for distributor roads with less desirable place characteristics.

Permeability of places is a crucial component in good street design. Internal permeability is important, but any area should also be properly connected with adjacent street networks. A development with poor links to the surrounding area creates an enclave which encourages movement to and from it by car rather than by other modes. New developments and alterations to existing street networks should be designed with multiple access points that connect with, and complement, existing street patterns.

### The movement framework

A key consideration for achieving sustainable development is how design can influence the way that people choose to travel. Designers need to respond to a wide range of policies aimed at making car use a matter of choice rather than habit or dependence. Regional and local transport strategies can directly inform the design process as part of the policy implementation process.

It is recommended that the movement framework for a new development is based on the user hierarchy in the previous section, *Pedestrians and cyclists*. Applying the hierarchy will lead to a design that increases the attractiveness of walking, cycling and the use of public transport. Delays to cars resulting from adopting this approach are unlikely to be significant in residential areas. The movement framework should also take account of the form of the buildings, landscape and activities that contribute to the character of the street and the links between new and existing routes and places.

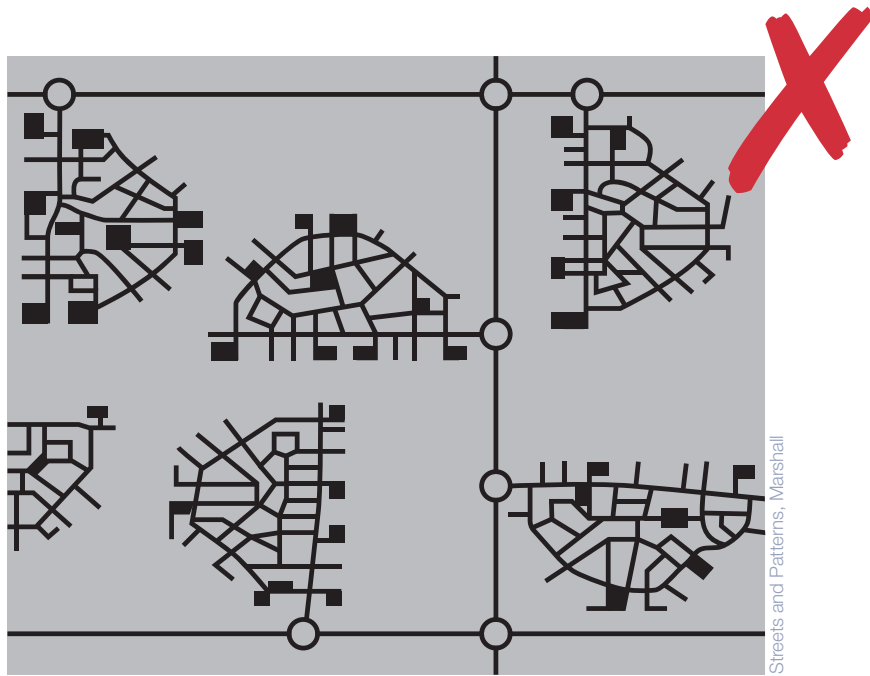

Internally permeable neighbourhoods lacking direct connections with one another – to be avoided

● Bus stop    ↔ Principal routes    ↔ Internal streets

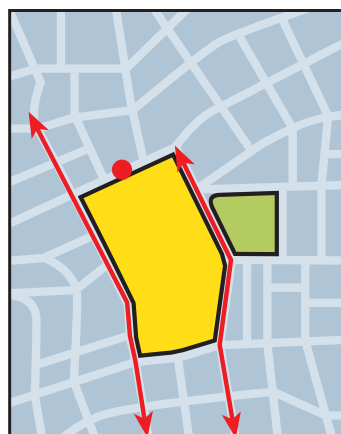

Consider how best the site can be connected with nearby main routes and public transport facilities

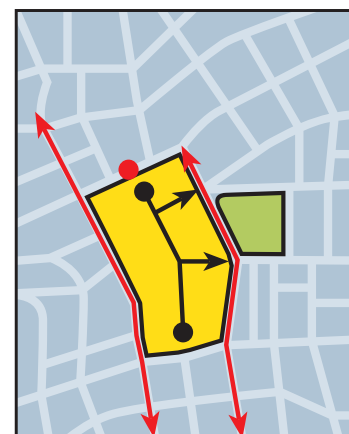

The typical cul-de-sac response creates an introverted layout which fails to integrate with its surroundings

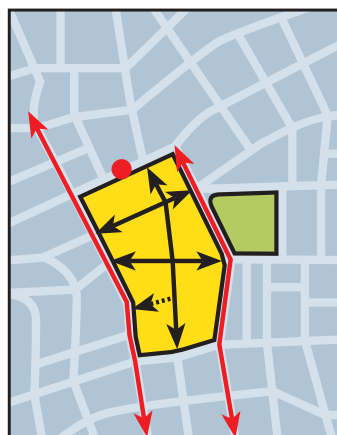

A more pedestrian friendly approach that integrates with the surrounding community – it links existing and proposed streets and provides direct routes to bus stops

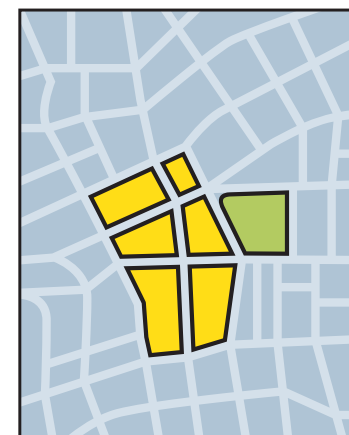

The street pattern then forms the basis for perimeter blocks which ensure that buildings contribute positively to the public realm

Integrating new developments into the existing urban fabric is essential

## Connections within a place

### Key consideration

- Street design should provide good connectivity for all modes of movement and for all groups of street users, respecting diversity and inclusion

### Connected street networks

In recent decades, the dominant patterns of development have been those in which housing, employment, retail and other facilities have been created in a segmentary fashion or zoned in separate areas, which are often poorly connected with one another. Such developments often increase the reliance on car use and discourage movement on foot.

Government policy now supports the creation of mixed-use neighbourhoods with well-connected street patterns, where daily needs are within walking distance of most residents. Layouts built on these more traditional lines are likely to be more adaptable and will lead to lower car use, thus contributing to wider transportation and environmental objectives.

The dispersed and zoned layout, as shown in the suburban sprawl diagram opposite, should not be used when designing new developments and this model should be avoided, where practicable, when considering existing or infill developments.



Developments and streets should generally be structured around a compact and walkable layout. The diagram illustrating mixed and connected neighbourhoods, opposite, illustrates how this can be achieved; these layouts have a mix of uses spread throughout, rather than a zoned approach to use.

To create a permeable network, it is generally recommended that streets with one-way operation are avoided. They require additional signs and result in longer vehicular journeys and higher speed.





# Case study

## Residential streets: Polnoon

Polnoon is located at the western edge of Eaglesham village, an 18th-century Conservation Area village in East Renfrewshire. Planning permission for the site had been obtained in 2006 for the development of housing in a typical standards-led, cul-de-sac layout.

In 2008, the Scottish Government, Mactaggart & Mickel Ltd and East Renfrewshire Council worked in a collaborative process to re-design the site to develop a new neighbourhood in accordance with the principles of *Designing Streets* and *Designing Places*.

The sequence of diagrams illustrates the differences between the initial cul-de-sac layout and the more permeable, pedestrian-friendly design developed through the collaborative re-design process.

The new layout offers a clear hierarchy of shared surface public realm spaces – streets, lanes, courtyards and a central square – which were designed to reduce vehicle speeds and create a more pedestrian-friendly environment. The re-designed new neighbourhood contains improved spatial permeability, an increased density from 92 to 121 dwellings and a more contextual treatment for standard house type elevations. Planning permission and RCC processes were run in parallel.

## B-Plan

A simple, but key technique which was used in developing the Polnoon masterplan was the Bavarian B-Plan tool. This is an effective method for developing ideas by colour coding the three key issues in a layout: ‘movement’ in yellow, ‘buildings’ in red and ‘open space’ in green. The B-Plan images to the right show the differences between the previous consent and the re-designed masterplan.

The Polnoon project sets a new standard for residential development across Scotland. The project clearly illustrates that, by putting place before movement when considering the design of streets, a better place can be created.

Detailed information on the Polnoon project can be found at: [www.scotland.gov.uk/Topics/Built-Environment/AandP/Projects/Polnoon](http://www.scotland.gov.uk/Topics/Built-Environment/AandP/Projects/Polnoon)



## Layout



Before – Cul de sac



After – Hierarchy of streets

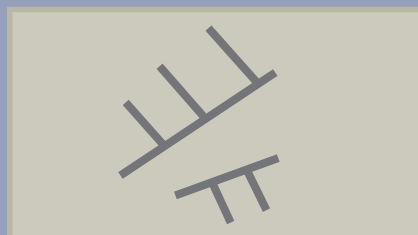

Before

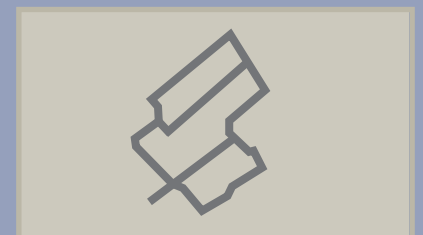

After

## Bavarian B Plan: Bringing movement, buildings and open space all together



Before

- 18% Movement
- 15% Buildings
- 15% Open space (Public)
- 52% Open space (Private)

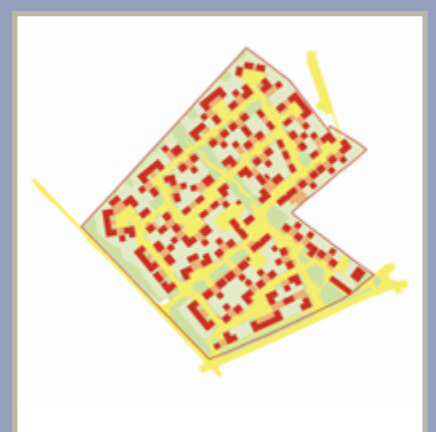

After

- 23% Movement
- 20% Buildings
- 15% Open space (Public)
- 42% Open space (Private)

## Block structure

### Key consideration

- The urban form should be distinctive with landmarks and vistas that provide good orientation and navigation of an area

### Structure

The structure of a street network can take a variety of forms, from formal grid layouts to more irregular arrangements.

It is important to consider the street structures that are appropriate in any given situation. It may be that an existing grid structure is continued in order to maintain connectivity or perhaps it may be more appropriate to break an existing pattern to respond to important external factors such as vistas, topography or significant building lines. What is important is that responses to layout structure should be design-led and responsive to context. They should not be the product of standard approaches or the application of inappropriate models.

The principle of integrated access and movement means that the perimeter block is usually an effective structure for residential neighbourhoods. A block structure works in terms of providing direct, convenient, populated and overlooked routes. In addition, it makes efficient use of land, offers opportunities for enclosed private or communal gardens, and is a tried and tested way of creating quality places.

Within a block structure, the designer has more freedom to create innovative layouts. The layouts illustrated in this section, and variations on them (such as a 'broken grid' with the occasional courtyard), are recommended when planning residential and mixed-use neighbourhoods.

Consideration should be given to the layout and impact of Sustainable Urban Drainage Systems (SUDS) when working on street and block layouts, as these can have determining effects on the overall urban structure. Detailed guidance on SUDS is given in this document in the section *Street detail, Drainage*.

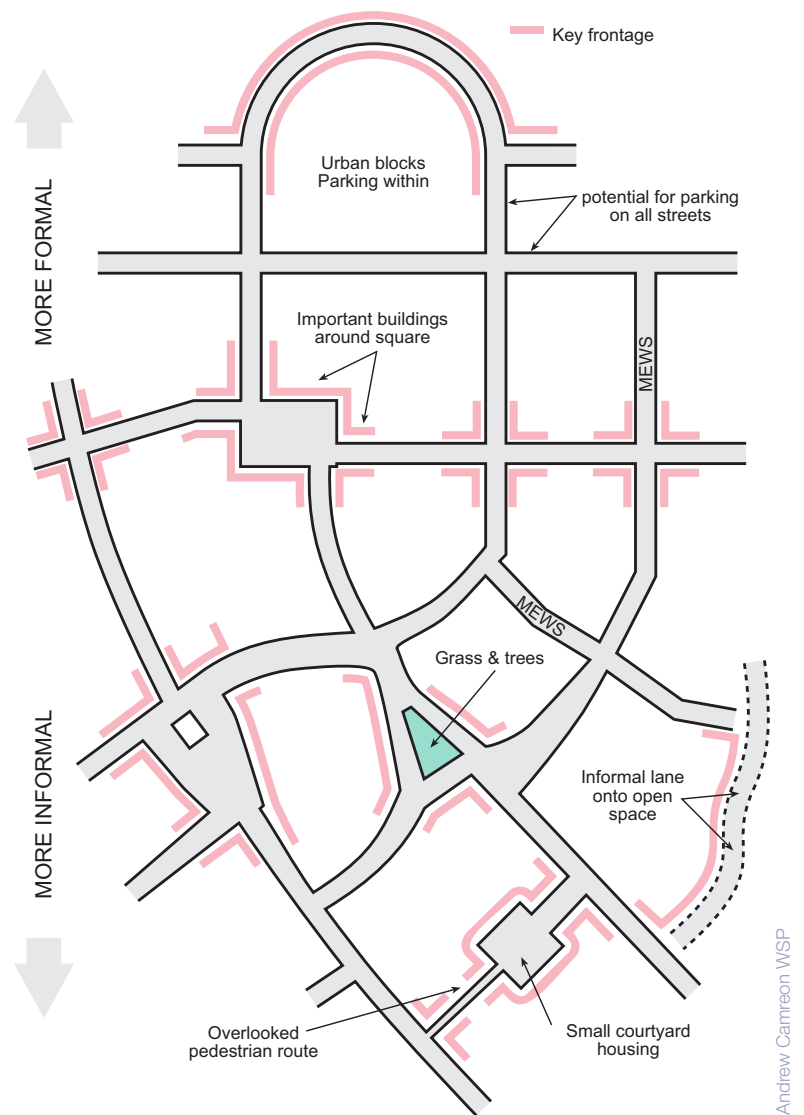

Diagram illustrating a range of street and place typologies

Andrew Camrean WSP

## Street patterns

Short and curved or irregular streets can contribute to variety and a sense of place, and may also be appropriate where there are topographical or other site constraints, or where there is a need to introduce some variation for the sake of interest. However, layouts that use excessive or gratuitous curves should be avoided, as they are less efficient, reduce legibility and make access for pedestrians and cyclists less direct.

Straight streets maximise connections between places and can better serve the needs of pedestrians who prefer direct routes. The regular spacing of junctions, where drivers are required to slow, can be an effective method for reducing vehicle speeds on straight road layouts.

Conventional culs-de sac, are strongly discouraged. The preference is for networked routes and spaces which connect new residential and mixed use areas together and link with existing development forms.

Short culs-de sac may occasionally be required because of topography, boundary or other constraints. Caution must, however, be exercised when planning for culs-de sac, as they concentrate traffic impact on a small number of dwellings, require turning heads that are wasteful in land terms and lead to additional vehicle travel and emissions, particularly by service vehicles. Through connections for pedestrians and cyclists should be provided where possible but should be wide, well lit and well overlooked with active frontages.



Rectilinear grid



Concentric grids designed to promote access to local centres or public transport routes



Irregular layouts

Variations in block structure

## Backs and fronts

In general, it is recommended that different treatments are employed in the design of the fronts and backs of houses and other buildings. The basic principle is 'public fronts and private backs'.

Exceptions to this may be employed where the building form contains a double frontage, such as a colony house type. Colony streets can increase the density of a typical terrace and provide positive street edges in a distinctive manner.

Busier streets should also follow this principle. Frontage development and multiple access points on busier streets add to activity intensity and traffic calming as well as a sense of place.

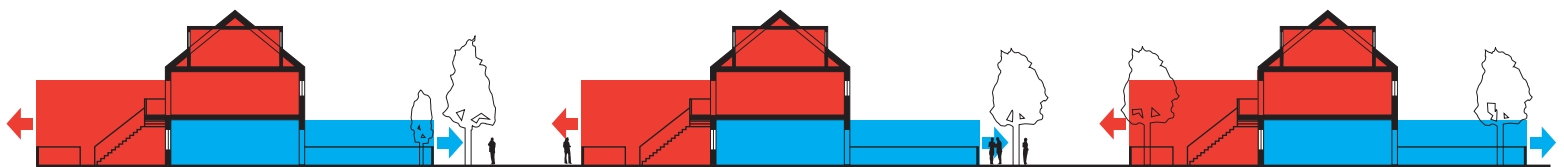

Section through colony street illustrating double frontage

## Width

Width between buildings is a key dimension and needs to be considered in relation to function and aesthetics. There are no fixed rules on street widths but account should be taken of the variety of activities taking place in the street and of the scale of the buildings on either side. The distance between frontages in residential streets typically ranges from 10 m to 18 m, although there are examples of widths significantly less than this working well.

Rigid standards on street widths should be avoided and new streets should be laid out with consideration given to the relationship between scale and the nature of the space created.

## Height

The public realm is defined by height as well as width or, more accurately, the ratio of height to width. It is therefore recommended that the height of buildings (or mature trees where present in wider streets) is in proportion to the width of the intervening public space to achieve the level of enclosure appropriate to the character and function of the street. Where building height is increased, it is important to avoid creating spaces with an oppressive or claustrophobic nature.

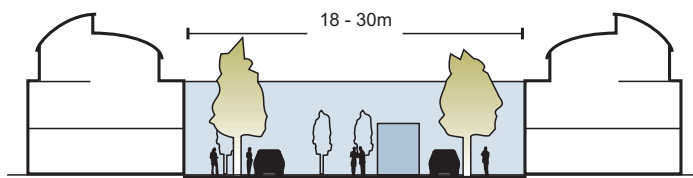

High street

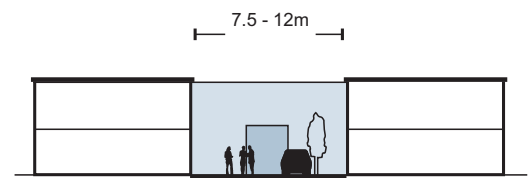

Mews

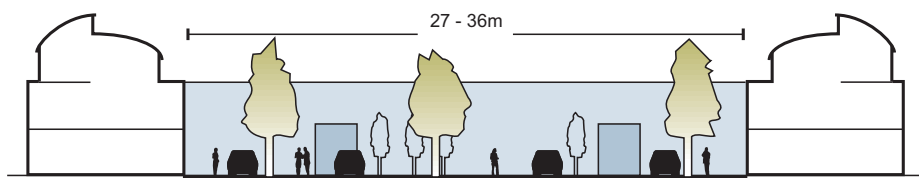

Boulevard

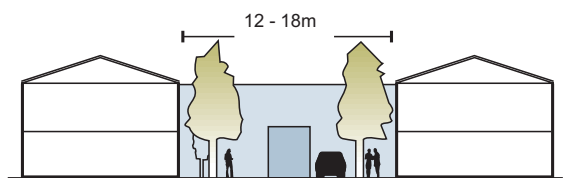

Residential street

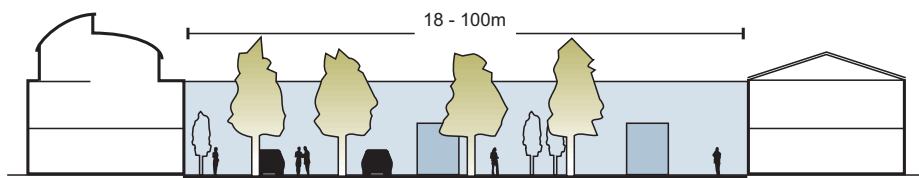

Square

## Length

Street length can have a significant effect on the quality of a place. Acknowledging and framing vistas and landmarks can help bring an identity to a neighbourhood and orientate users. However, long straights can encourage high traffic speeds, which should be mitigated through careful design (see *Street Layout* section – *Achieving Appropriate Traffic Speeds*).

## Buildings at junctions

The arrangement of buildings and footways has a major influence on defining the space at a junction. It is better to design the junction from this starting point rather than purely on vehicle movement. In terms of streetscape, a wide carriageway with tight, enclosed corners makes a better junction than cutback corners with a sweeping curve. This might involve bringing buildings forward to the corner. Junction treatments are explored in more detail in the *Street Layout* section.



Variation in building height can add visual interest

John Thompson & Partners



## Squares & spaces

A street and block structure can be enhanced with punctuations of public space. This may take the form of parks, green edges or formal and informal squares. The introduction of small, informal squares in a residential area can support navigation, provide social areas for people to gather and children to play, slow traffic speed and create positive character.

The design of squares, both small and large, should respond to the context of the place. A square will not be successful unless it is aligned with the potential activities of a place and the building forms.



Cedell 2

Small residential square



Malcolm Fraser Architects



HTA, Oakridge village

Local neighbourhood square



HTA, Oakridge village



J Cooper

Large urban square

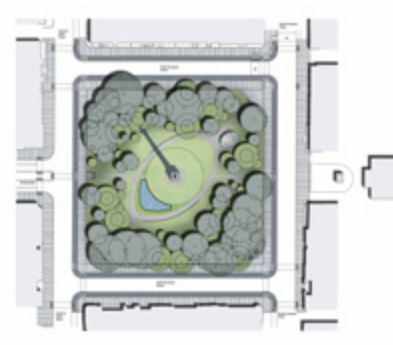

Gillespies

## Other layout considerations

The layout of a new housing or mixed-use area should take account of the following factors:

- ▶ the need to reduce the dominance of vehicle traffic;
- ▶ the need to mitigate noise pollution such as from roads or railways;
- ▶ the importance of orientation, variety and visual interest (The provision of views and vistas, landmarks, gateways and focal points are means to emphasise urban structure, hierarchies and connections.);
- ▶ the need for crime prevention, including the provision of defensible private and communal space, and active, overlooked streets (An appropriate mix of uses can often encourage activity and movement at all times.);
- ▶ the management of the transition from the public to the private realm (The space between the fronts of buildings and carriageways, footways or other public spaces needs to be carefully considered. Continuous building lines are preferred as they provide definition to, and enclosure of, the public realm.);
- ▶ the handling of building lines (Where no front garden is provided, the setback of dwellings from the street is a key consideration in terms of: defining the character of the street determining a degree of privacy; amenity space for plants or seating, etc.; and functional space for rubbish bins, external utility meters or storage, including secure parking for bicycles.); and
- ▶ the handling of car parking (Keeping garages and parking areas level with, or behind, the main building line can be aesthetically beneficial in streetscape terms.).

## Walkable neighbourhoods

### Key consideration

- ▣ Street layouts should be configured to allow walkable access to local amenities for all street users

### The walkable neighbourhood

Walkable neighbourhoods are characterised by having a range of facilities within 5 minutes (up to about 400m) walking distance of residential areas which residents may access comfortably on foot. Where amenities cannot be provided within this area, good public transport links to relevant facilities should be accessible.

In many cases, it may be better for a new development to reinforce existing centres and facilities rather than providing alternative facilities.

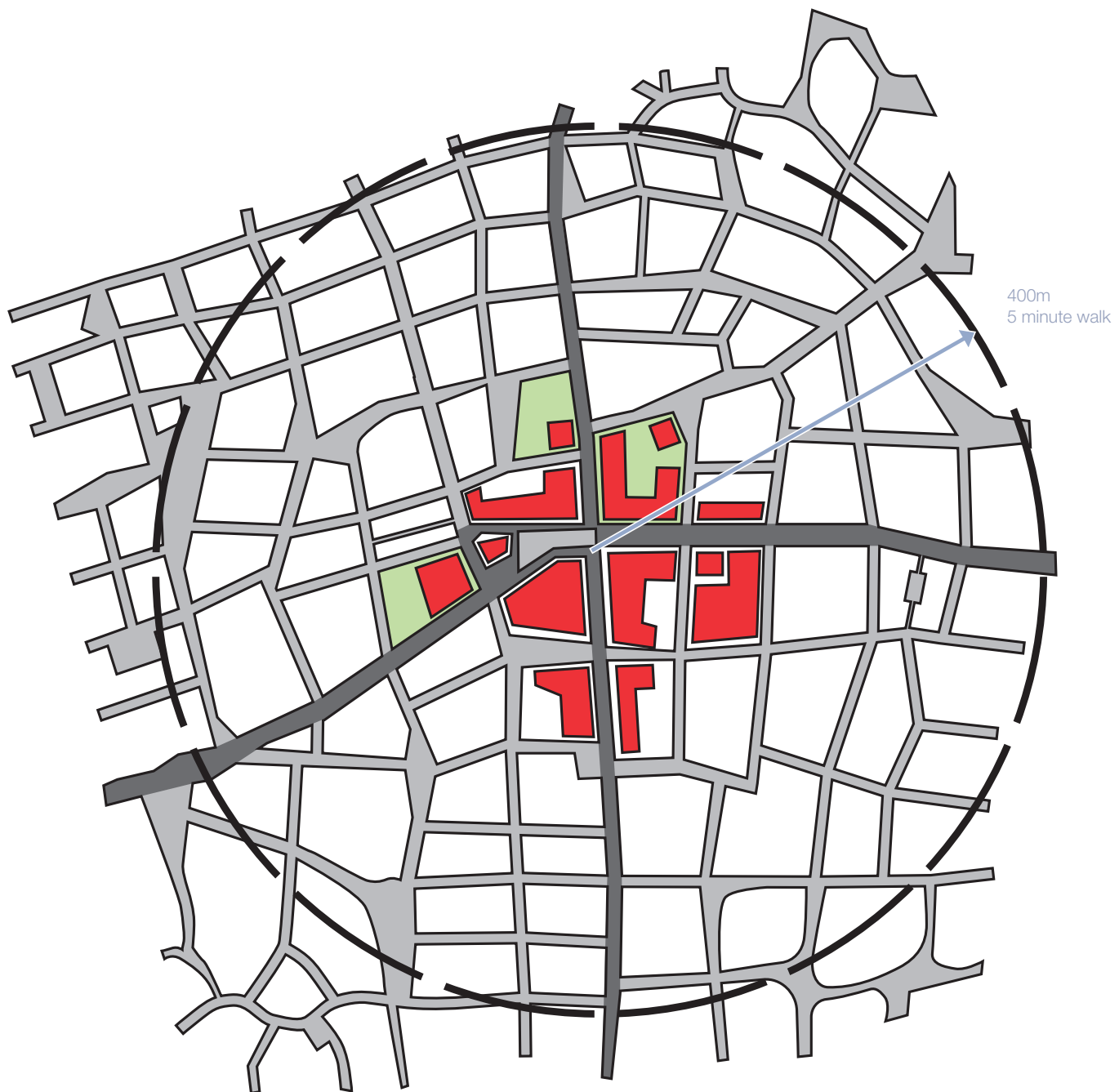

Andrew Cameron WSP



Walkable neighbourhoods should be on an appropriate scale, with pedestrian routes matching desire lines as closely as possible. Permeable networks help minimise walking distances.

Good connectivity and the formation of local or district centres are key to establishing walkable neighbourhoods. By concentrating facilities along key routes and junctions, particularly at the convergence of main routes, neighbourhood centres can be established that contribute both practical services and a local identity to a place. Within the larger context, walkable neighbourhoods should have good linkages to other local centres, building a larger network of distinct neighbourhoods. The hierarchy and scale of these neighbourhoods can vary within a town or city; the greater the density of development, the more facilities can be supported.

Density is also an important consideration in reducing reliance on the private car. *Scottish Planning Policy* encourages a flexible approach to density, reflecting the desirability of using land efficiently and the need to promote higher density development in places well served by public transport. Residential densities should be planned to take advantage of proximity to activities, or to good public transport linking those activities.





## Public transport

### Key consideration

- Public transport planning should be considered at an early stage in the design process

### Bus routes

The principal streets within a development should be the streets on which public transport runs. These should be identified in the design process, working in partnership with public transport operators. Bus routes and stops should form key elements of the walkable neighbourhood. Designers and local authorities should try to ensure that development densities will be high enough to support a good level of service without long-term subsidy. Layouts designed with strong connections to local networks, and which avoid long one-way loops or long distances without passenger catchments, are likely to be more viable.

Using a residential street as a bus route need not require restrictions on direct vehicular access to housing. Detailed requirements for streets designated as bus routes can be determined in consultation with local public transport operators. Streets on bus routes should not generally be less than 6.0 m wide (although this could be reduced on short sections with good inter-visibility between opposing flows). The presence and arrangement of on-street parking, and the manner of its provision, may affect width requirements.

Swept-path analysis can be used to determine the ability of streets to accommodate large vehicles. When considering the level of provision required for the movement of buses, account should be taken of the frequency and the likelihood of two buses travelling in opposite directions meeting each other on a route.

### Bus stops

In new developments, it is essential to consider the siting of public transport stops and related pedestrian desire lines at an early stage of design. Close co-operation is required between public transport operators, the local authorities and the developer.

- Bus stops should be sited so they can be easily accessed by all pedestrians.
- Bus stops should be placed near junctions so that they can be accessed by more than one route on foot, or near specific passenger destinations. (schools, shops, etc.)
- The bus should generally stop on the street and not in a lay-by.
- Bus stops should be high-quality places that are safe and comfortable to use.
- Footways at bus stops should be wide enough for waiting passengers while still allowing for pedestrian movement along the footway. This may require local widening at the stop.
- Provision should be made within the streetscape for features that assist passengers getting on and off buses. This may involve areas of raised footway. It is important that such features are integrated within the overall design of the street and do not pose difficulties for those with visual impairments.

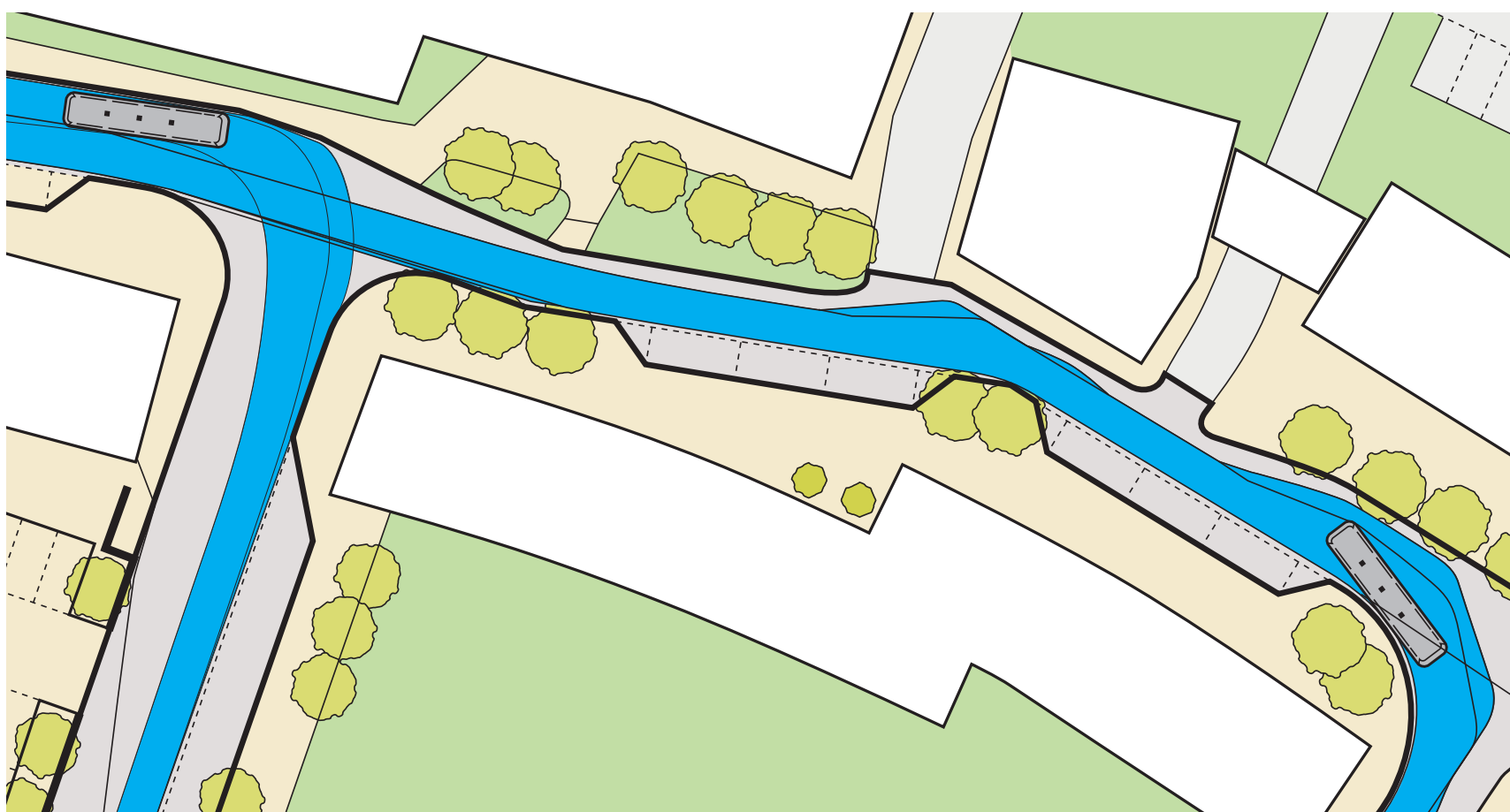

## Context and character

### Key consideration

- ▣ The requirements and impact of pedestrians, cycles and vehicles should be reconciled with local context to create streets with distinctive character
- ▣ Opportunities should be taken to respond to, and to derive value from, relevant elements of the historic environment in creating places of distinctive character

### Character

Streets and the public realm at large play an important part in the development and expression of local character and culture. The character of a place is not determined by the particular materials or physical appearance of a place alone, but also by the patterns of movement and social interaction that it produces. When considering the structure of streets, it is important that street and block forms are selected that will enhance the character of an area.

Street character types in new residential developments should be determined by a sensitive response to site conditions as well as the relative importance of both place and movement functions. When developing layouts, consideration should be given to the character of each individual street as well as the overall urban structure.

Scotland has a wide range of distinctive street typologies and the successful arrangement of these can result in networks with positive characters. When developing street networks it can be useful to consider typologies such as the following, in order to create distinctive environments:

- ▣ **high street**
- ▣ **mixed-use street**
- ▣ **square**
- ▣ **crescent/circus**
- ▣ **mews**
- ▣ **terrace/row**
- ▣ **colony**
- ▣ **tenement block**
- ▣ **avenue**
- ▣ **courtyard**
- ▣ **cross**
- ▣ **lane/loan**
- ▣ **vennel/wynd**

The above list is not exhaustive. It is important that the individual characteristics of any of the above street types are well defined and meaningful. Site specific design codes can ensure that the principal elements of a street's character are controlled and distinct.

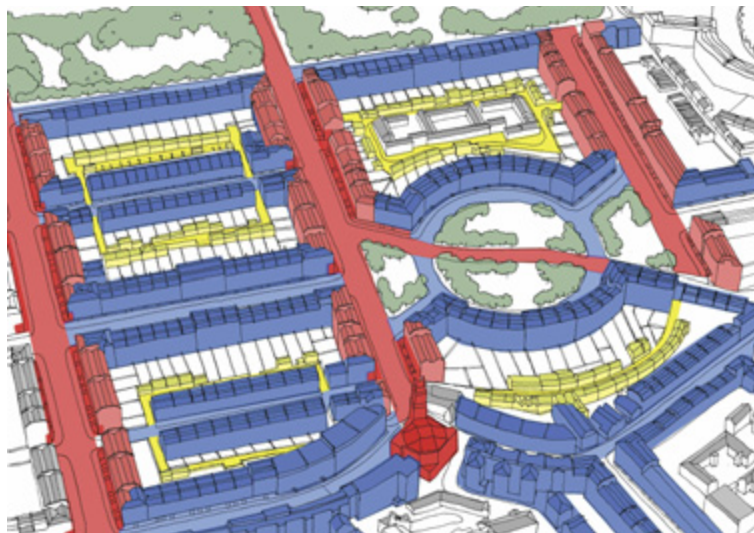

The street hierarchy of Edinburgh New Town accommodates variety of character within a cohesive urban structure



Main avenue mixed-uses/primary zone



Residential street/secondary zone



Residential and service lane/tertiary zone



## Variety

Character can be enhanced and emphasised by variety in the streetscape. Punctuating key views with landmarks or green edges can provide visual cues that aid navigation as well as helping to develop areas of individual character within the overall urban structure. Developing a series of linked spaces with distinctive identities can also aid navigation while providing a cohesive character for a neighbourhood. By employing a network of varied streets, each with particular characteristics, a diverse streetscape with varied visual interest can be achieved. Variation in scale and density can develop areas with distinct physical characteristics as well as reflecting the types of activities that take place in the area.



Landmark/vista stop helps to develop a unique character, emphasise street hierarchy and aid navigation



Green edge signifies a significant junction and a change in street pattern as well as offering visual relief and local amenity



Ground floor commercial and retail space also emphasises the street hierarchy, provides amenity and an active street edge



## Orientation

### Key consideration

#### ▣ Orientation of buildings, streets and open space should maximise environmental benefits

The orientation of streets can have a large impact on the environmental performance of buildings as well as contributing to perceptions of safety and attractiveness.

### Solar impact

Bright, sunny streets can foster a positive sense of place. The layout of streets should be considered in relation to building heights to maximise the amount of light reaching the public realm. This is particularly important in areas where people gather and activities take place. Local shops and facilities should be arranged to provide southerly aspects to the activities that will most benefit from bright, attractive external space.

By arranging streets so that buildings are able to maximise solar gain, it is possible for buildings to reduce heat and light requirements. Principal elevations should address the sun path wherever possible and the presentation of blank gables to the south should be avoided.

On occasion, it may be that narrow, intimate streets are appropriate to a particular context and will not require to have as direct a relationship to the sun path as a large public boulevard or square.

### Prevailing wind

Traditionally, many street layouts evolved to respond directly to the prevailing wind direction. This led to streets where pedestrians were sheltered from the extremities of the environment, ultimately producing streets where people were more likely to gather and take ownership of a place. This also led to patterns of development that were particular or unique to the microclimate of a settlement and helped to evolve a distinctive local design response.

Designers should take prevailing wind conditions into account to maximise on-street shelter and also to minimise the impact of cold air infiltration into buildings. This can have an impact on the direction of streets, the scale of individual buildings, street width and the relationship of a settlement to natural landscape features.

# Street layout

## Achieving appropriate traffic speed

### Key consideration

- ▣ **Design should be used to influence driver behaviour to reduce vehicle speed to levels that are appropriate for the local context and deliver safe streets for all**

For residential streets, a maximum design speed of 20 mph should normally be an objective.

Designers should aim to create streets that control vehicle speeds naturally by well-crafted design from the outset rather than through unsympathetic traffic-calming measures added at the end of the design process.

The provision of separate pedestrian and/or cycle routes away from motor traffic should only be considered as a last resort. Research has shown that the presence of pedestrians has an effect in reducing traffic speeds.

Evidence from traffic calming schemes suggests that speed-controlling features are needed at intervals of around 60-80m in order to achieve speeds of 20 mph or less. Straight and uninterrupted links should therefore be limited to this range to help ensure that the arrangement has a natural traffic-calming effect. Designs should not rely solely on conventional traffic calming techniques, such as speed cushions and humps; these do little to develop a positive sense of place. Instead, speed-controlling features should be built into the layout of the street, taking advantage of building alignment, parking, road narrowings, landscaping and other design features, rather than resorting solely to vertical deflection.

The range of traffic-calming measures available act in different ways:

- ▣ **Psychology and perception** – play a strong part in influencing driver behaviour. Street features and human activity can influence the speed at which people choose to drive. Features likely to be effective include:
  - edge markings that visually narrow the road – speed reduction is likely to be greatest where the edging is textured to appear unsuitable on which to drive;
  - buildings in close proximity to the street;
  - reduced carriageway width;
  - physical features in the carriageway;
  - features associated with potential activity in, or close to, the carriageway, such as pedestrian refuges;
  - on-street parking, particularly when the vehicles are parked in blocks on alternate sides of the street, either in echelon formation or perpendicular to the carriageway;
  - the types of land use associated with greater numbers of people, for example shops; schools and places of work; and
  - landscaping.

- ▣ **Street dimensions** – can have a significant influence on speeds. Keeping lengths of street between junctions short is particularly effective.
- ▣ **Reductions in forward visibility** – are associated with reduced driving speeds.
- ▣ **Changes in priority/or no priority** – at junctions. This can be used to disrupt flow and therefore bring overall speeds down.
- ▣ **Physical features** – involving vertical or horizontal deflection can be very effective in reducing speed.
- ▣ **Materials** – can reduce speed by both visual perception and by physical characteristics, such as cobbled surfaces.

Reductions in carriageway width are most effective in reducing driving speed.



Trees planted in the highway at Newhall, Harlow, help to reduce vehicle speeds

EDAW

## Stopping sight distance

The stopping sight distance (SSD) is the distance within which drivers need to be able to see ahead and stop from a given speed.

The SSD values used in *Designing Streets* are based on research into deceleration rates, driver perception-reaction times and speed. These SSD values are appropriate for residential and lightly trafficked streets. The table below shows the effect of speed on SSD. These values are independent of traffic flow or type of road. It is recommended that they are used on all streets with 85th percentile wet weather speeds up to 60 kph.

Below around 20 mph, shorter SSDs themselves may not achieve low vehicle speeds: the design of the whole street and how this will influence speed needs to be considered at the start of the process; e.g. the positioning of buildings and the presence of on-street parking.

Further information on SSDs, including details of the calculation formula, and also the relationship between visibility and speed is available in *TRL Report No. 332*<sup>11</sup> and *TRL Report No. 661*<sup>12</sup>.

Speed	Kilometres per hour	16	20	24	25	30	32	40	45	48	50	60
	Miles per hour	10	12	15	16	19	20	25	28	30	31	37
	SSD (metres)	9	12	15	16	20	22	31	36	40	43	56
	SSD adjusted for bonnet length	11	14	17	18	23	25	33	39	43	45	59

## Visibility requirements

Visibility should be checked at junctions and along the street. Visibility is measured horizontally and vertically.

Using plan views of proposed layouts, checks for visibility in the horizontal plane ensure that views are not obstructed by vertical obstructions.

Checking visibility in the vertical plane is then carried out to ensure that views in the horizontal plane are not compromised by obstructions such as the crest of a hill, or a bridge at a dip in the road ahead. It also takes into account the variation in driver eye height and the height range of obstructions. Eye height is assumed to range from 1.05 m (for car drivers) to 2 m (for lorry drivers). Drivers need to be able to see obstructions 2 m high down to a point 600 mm above the carriageway.

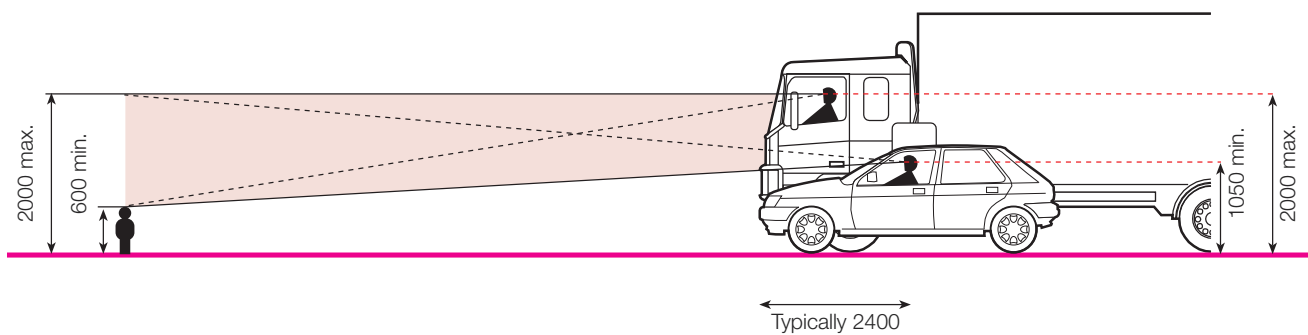



## Visibility splays at junctions

The visibility splay at a junction ensures there is adequate inter-visibility between vehicles on the major and minor arms.

The distance back along the minor arm from which visibility is measured is known as the X distance. It is generally measured back from the 'give way' line (or an imaginary 'give way' line if no such markings are provided). This distance is normally measured along the centreline of the minor arm for simplicity, but in some circumstances (for example where there is a wide splitter island on the minor arm) it will be more appropriate to measure it from the actual position of the driver.

The Y distance represents the distance that a driver who is about to exit from the minor arm can see to his left and right along the main alignment. For simplicity, it is measured along the nearside kerb line of the main arm, although vehicles will normally be travelling a distance from the kerb line. The measurement is taken from the point where this line intersects the centreline of the minor arm (unless, as above there is a splitter island in the minor arm).

When the main alignment is curved and the minor arm joins on the outside of a bend, another check is necessary to make sure that an approaching vehicle on the main arm is visible over the whole of the Y distance. This is done by drawing an additional sight line which meets the nearest wheel track at a tangent.

Some circumstances make it unlikely that vehicles approaching from the left on the main arm will cross the centreline of the main arm – opposing flows may be physically segregated at that point, for example. If so, the visibility splay to the left can be measured to the centreline of the main arm.

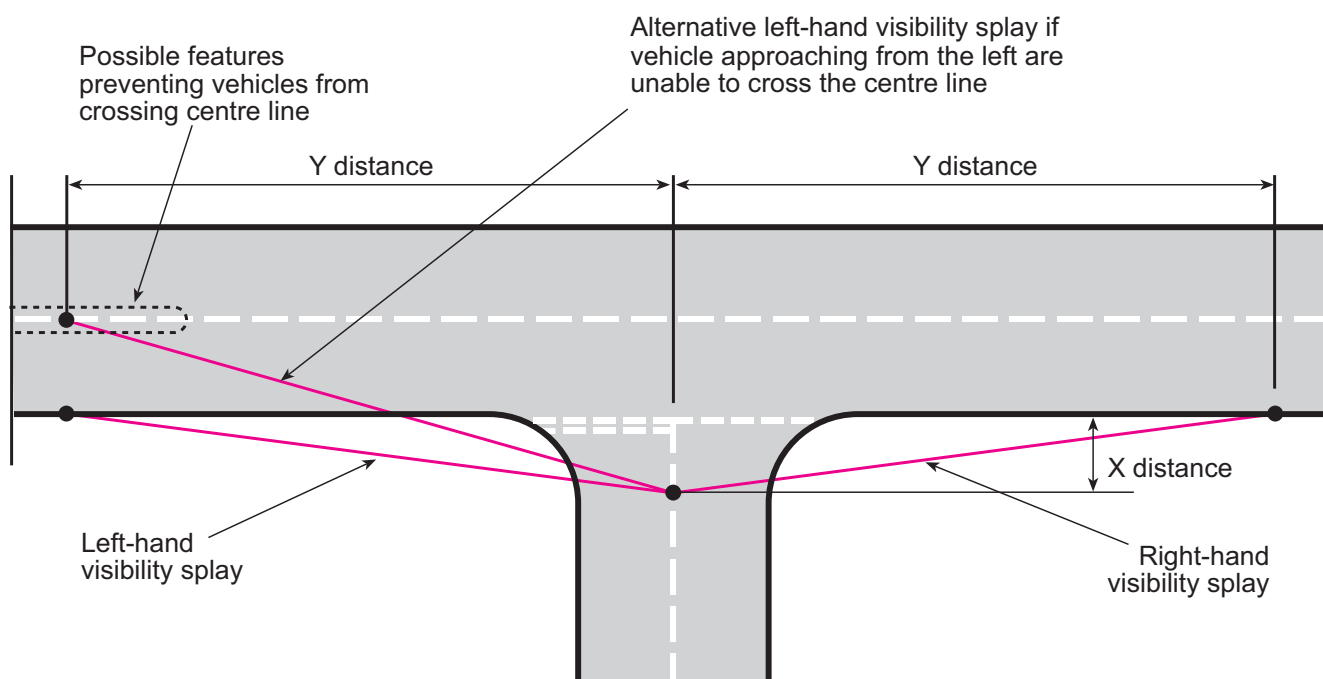

## X and Y distances

An X distance of 2.4 m should normally be used in most built-up situations, as this represents a reasonable maximum distance between the front of the car and the driver's eye.

A minimum figure of 2 m may be considered in some very lightly-trafficked and slow-speed situations, but using this value will mean that the front of some vehicles will protrude slightly into the running carriageway of the major arm. The ability of drivers and cyclists to see this overhang from a reasonable distance, and to manoeuvre around it without undue difficulty, should be considered.

Using an X distance in excess of 2.4 m is not generally required in built-up areas.

The Y distance should be based on values for SSD.

## Forward visibility

Forward visibility is the distance a driver needs to see ahead to stop safely for obstructions in the street. The minimum forward visibility required is equal to the minimum SSD. It is checked by measuring between points on a curve along the centreline of the inner traffic lane. Consideration should be given to vertical geometry and any other obstructions.

There will be situations where it is desirable to reduce forward visibility in conjunction with other methods to control traffic speeds.



Andrew Cameron WSP

An example of the reduction in forward visibility to reduce vehicle speed

## Visibility along the street edge

Vehicle exits at the back edge of the footway mean that emerging drivers will have to take account of people on the footway. The absence of wide visibility splays at private driveways will encourage drivers to emerge more cautiously. Consideration should be given to whether this will be appropriate, taking into account the following:

- ▶ the frequency of vehicle movements;
- ▶ the amount of pedestrian activity; and
- ▶ the width of the footway.

## Obstacles to visibility

Parking in visibility splays in built-up areas is quite common, yet it does not appear to create significant problems in practice. Defined parking bays can be provided outside the visibility splay if required, and the use of tracked streets that allow for informal parking is also an option. Encroachment of parking space into visibility splays should be avoided where practical.

The impact of other obstacles, such as street trees and street lighting columns, should be assessed in terms of their impact on the overall envelope of visibility. In general, occasional obstacles to visibility that are not large enough to fully obscure a whole vehicle or a pedestrian, including a child or wheelchair user, will not have a significant impact on road safety.

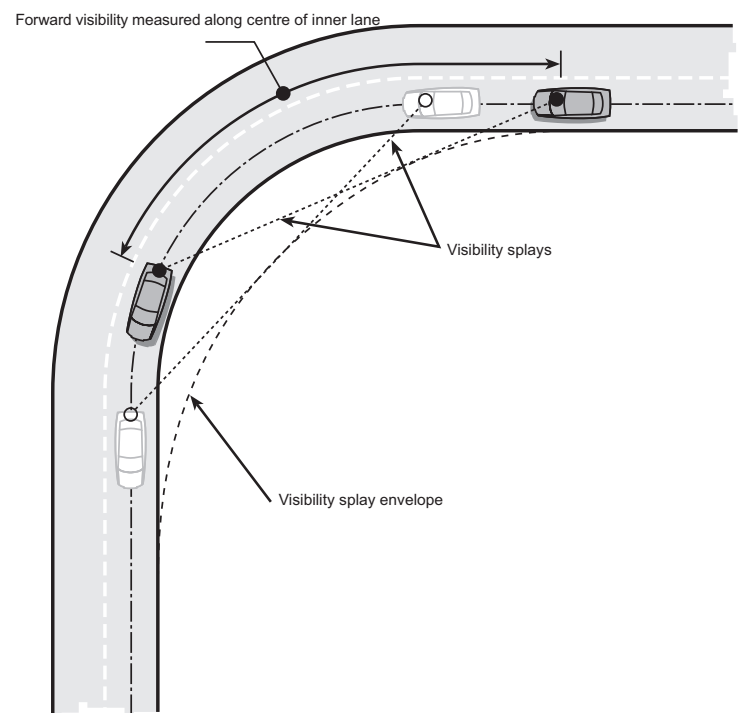

Measurement of forward visibility

## Junction types and arrangements

### Key consideration

- ▣ Junctions should be designed with the considerations of the needs of pedestrians first
- ▣ Junctions should be designed to suit context and urban form – standardised forms should not dictate the street pattern

### Junctions

The success of a well-designed junction frequently derives from the way in which buildings frame the space in which the junction sits. Decisions on building placement should be made first, with the quality of the space in mind, and the junction then designed to suit the space created.

Junctions that should be used in residential areas include:

- ▣ crossroads and staggered junctions;
- ▣ T and Y junctions;
- ▣ formal and informal squares; and
- ▣ mini roundabouts.















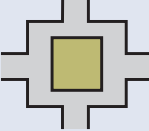
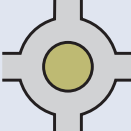



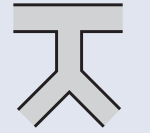
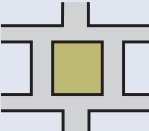

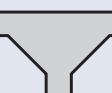

Junctions are generally places of high accessibility and good natural surveillance. Junctions generally, and crossroads junctions in particular, are therefore ideal places for locating facilities such as public buildings, shops and public transport stops.

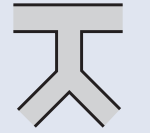
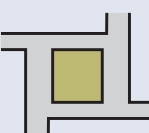
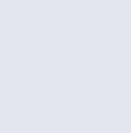
Junction design should facilitate direct pedestrian desire lines, and this will often mean using small corner radii. The use of swept path analysis will ensure that the junctions are negotiable by vehicles. However, consideration should be given to the robustness of the design and quality of construction to withstand any occasional vehicle overrun.

Crossroads are convenient for pedestrians, as they minimise diversion from desire lines when crossing the street. They also make it easier to create permeable and legible street networks.

Where designers are concerned about potential user conflict, they may consider placing the junction within a square or on a speed table.

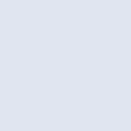
Conventional roundabouts are not generally appropriate for residential developments. Mini-roundabouts may have some application in residential areas, as they cause less deviation for pedestrians and are easier for cyclists to use. In addition, they do not occupy as much land. Practitioners should refer to *Mini-roundabouts: Good Practice Guidelines*<sup>13</sup>.

Nodal form	T	Y	Cross/ staggered	Multi-armed	Square	Circus	Crescent
Regular							
↑ ↓							
							
							
Irregular							





David Nicol, WSP

Quadrant kerbstones used instead of large radii at junctions reduce the dominance of the carriageway and respond to pedestrian desire lines – this is reinforced by the placement and form of the adjacent buildings

### Spacing of junctions

The spacing of junctions should be determined by the type and size of urban blocks appropriate for the development. Block size should be based on the need for permeability and, generally, tends to become smaller as density and pedestrian activity increases.

Smaller blocks create the need for more frequent junctions. This improves permeability for pedestrians and cyclists, and the impact of motor traffic is dispersed over a wider area. Junctions do not always need to cater for all types of traffic. Some of the arms of a junction may be limited to pedestrian and cycle movement only.

### Turning areas

Connected street networks will generally eliminate the need for vehicles to turn around.

Where it is necessary to provide for vehicles turning (e.g. in a cul-de-sac or court), a tracking assessment should be made to indicate the types of vehicles that may be making this manoeuvre and how they can be accommodated. The turning space provided should relate to its environment, not specifically to vehicle movement, as this can result in a space with no use other than for turning vehicles. To be effective and usable, the turning space must be kept clear of parked vehicles. It is essential, therefore, that adequate parking is provided for residents in suitable locations.

### Overrun areas

Overrun areas should generally be avoided in residential and mixed-use streets. They can:

- ▶ be visually intrusive;
- ▶ interfere with pedestrian desire lines; and
- ▶ pose a hazard for cyclists.

Overrun areas can, however, help to overcome problems with regular or high volume access for larger vehicles.

### Frontage access

One of the key differences between streets with a 30 mph speed restriction or below and roads is that streets normally provide direct access to buildings and public spaces. This helps to generate activity and a positive relationship between the street and its surroundings. Providing direct access to buildings is also efficient in land-use terms.

It is recommended that direct access on roads with a 30 mph speed restriction is acceptable with flows of up to 10,000 vehicles per day.

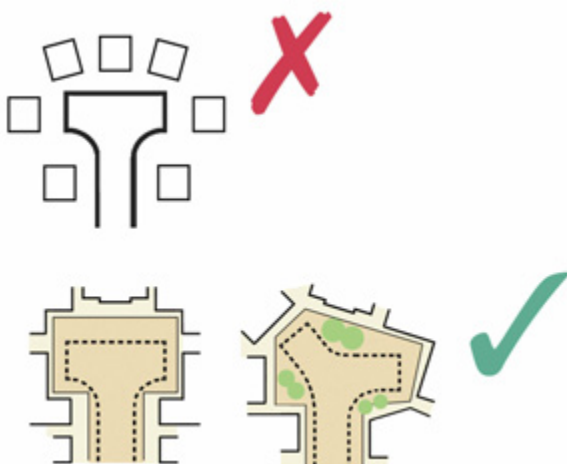

# Streets for people

## Key consideration

### Streets should allow for and encourage social interaction

#### Streets as social spaces

The design of all streets should recognise the importance of creating places for people to enjoy, rather than simply providing corridors for the movement of traffic. Streets should generally be designed with a focus on social interaction.

A significant amount of interaction within a community takes place in the external environment, and street design should encourage this by creating inclusive social spaces where children can play, people can stop to chat, and other appropriate activities can take place safely. In order for this to occur, it is essential that vehicular traffic does not dominate the street.

The propensity for people to use a street as a social space is increased by careful design and by applying the user hierarchy where pedestrians are considered first, as indicated in the section *Pedestrians and cyclists*.

#### Shared Space

A Shared Space is a street or place accessible to both pedestrians and vehicles that is designed to enable pedestrians to move more freely by reducing traffic management features that tend to encourage users of vehicles to assume priority.

Achieving this reduction in dominance can be assisted by the techniques described previously and also by the minimal use of traffic signs, road markings and other traffic management features where appropriate. With less, or no, traffic management measures giving clear indications of priority, motorists are encouraged to recognise the space as being different, drive more slowly, and respond directly to the behaviour of other users (including other motorists).

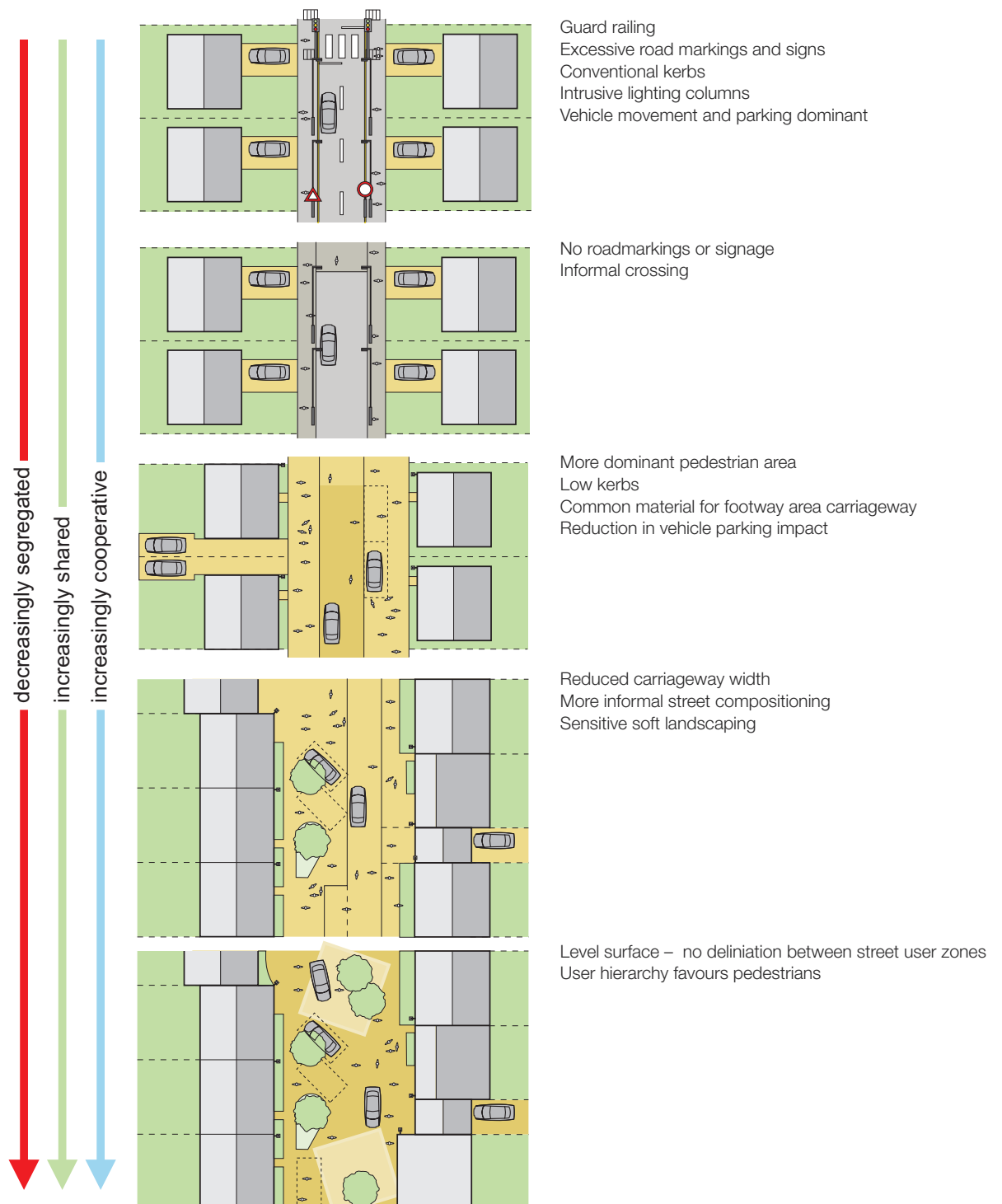

Home Zones are essentially Shared Spaces, and are provided in residential areas. Home Zones can be formally designated as such under Section 74 of the *Transport (Scotland) Act 2001*,<sup>14</sup> although there is no requirement to do so. Further guidance on the design of Home Zones concept schemes is given in *Home Zones; Challenging the future of our streets*<sup>15</sup>, *Home Zone Design Guidelines*<sup>16</sup> and at [www.homezones.org.uk](http://www.homezones.org.uk).

### Level surfaces

Some Shared Space schemes feature what is often referred to as a shared or level surface, although not all will do so. There is a variety of terminology used to describe this approach; this document will refer to the technique as a level surface. For the purposes of this guidance, a level surface is a street surface that is not physically segregated by kerb or level differences into areas for particular users. Level surfaces work best in relatively calm traffic environments.

The lack of defined areas for pedestrians and vehicles is intended to indicate that the street is meant to be shared equally by all users. Motorists are expected to adapt their behaviour to that of other street users, driving slowly and giving way as appropriate.

The key aims are to:

- ▶ encourage low vehicle speeds;
- ▶ create an environment in which pedestrians can walk, or stop and chat, without feeling intimidated by motor traffic;
- ▶ make it easier for people to move around, particularly wheelchair users and people pushing wheeled equipment such as prams; and
- ▶ promote social interaction.

In the absence of a formal carriageway, experience shows that motorists entering the area will tend to drive more cautiously and negotiate the right of way with pedestrians on a more conciliatory level.

Control of car parking needs to be considered in level surface areas. Car parking should be organised to deter cluttered streets and sufficient provision, including the provision of disabled parking spaces, should be allocated around a scheme to ensure that parking is distributed evenly and clearly.

Level surfaces are only one component of the principles of Shared Space and should not be solely relied upon to create good streets or to slow traffic.

### Ensuring inclusive design

Shared Space, and level surfaces in particular, can cause problems for some disabled people. The absence of a conventional kerb in level surfaces can pose problems for some blind or partially-sighted people, who often rely on this feature to find their way around. The lack of visual cues may also pose problems for pedestrians with cognitive difficulties. It is therefore important that level surface schemes include an alternative means by which visually-impaired people can navigate. Such elements can be designed in collaboration with local people, including representatives from local disability groups and access panels.

Disability groups should also be invited to provide input throughout the Quality Audit stages. Quality Audits are explained in more detail in Part 3 *How to achieve better outcomes*. Any design solution should be informed by local context and the local community.

Research commissioned by the Department for Transport looking into Shared Space is currently underway and is due for final publication in 2011. The first stage of the research was published in *Shared Space Project Stage 1: Appraisal of Shared Space*.<sup>17</sup>

The conclusions of this report include the statement that “evidence broadly suggests that Shared Space Schemes can deliver benefits: they appear to support economic activity, improve perceptions of personal security, be popular generally with the public and traders and increase freedom of movement for many people including some vulnerable pedestrians.” The report concluded that “a case can be made for level surfaces as a valid feature in some settings but that the detailed design of particular schemes needs to recognise and respond to the needs of all users.”

It should be noted that this is an intermediate report and its findings will be subject to final clarification. Final outcomes of this research should be taken into account when considering Shared Space.

Research commissioned by the Disabled Persons Transport Advisory Committee (DPTAC) on the implications of Home Zones for disabled people was published in 2007. *Designing for Disabled People in Home Zones*<sup>18</sup> contains relevant guidance.

### Surface treatments

Shared Space streets are often constructed from pavements or other materials rather than asphalt, which helps emphasise their difference from conventional streets. Research for *Manual for Streets* shows that block paving reduces traffic speeds by between 2.5 mph and 4.5 mph, compared with speeds on asphalt surfaces. The use of block paving can also provide permeable surfaces for drainage.

Block paving may not be appropriate in all Shared Space or level surface areas, and contextual circumstances are key to decisions on materials. Coloured or textured asphalts can provide an effective delineation. Many Scottish towns and villages contain existing areas of successful level surfaces that use traditional materials or simple asphalt surfaces.





## Integrating parking

### Key considerations

- ▣ Parking should be accommodated by a variety of means to provide flexibility and lessen visual impact

### Cycle parking

Providing enough convenient and secure cycle parking at homes and other locations for both residents and visitors is critical to increasing the use of cycles. In residential developments, designers should aim to make access to cycle storage at least as convenient as access to car parking.

Reference should be made to the relevant local guidance and any relevant travel plans to determine the appropriate level of provision of cycle parking. The following key principles should, however, apply:

- ▣ Shared cycle parking facilities should be secure, overlooked and convenient to use with shelter provided wherever practical.
- ▣ Appropriate provision should be made for all potential users including children and visitors.
- ▣ Cycle parking can be provided in a number of ways such as: within garages; bespoke cycle storage; communal areas in flats; and on-street cycle racks.
- ▣ Cycle stands need to be located clear of pedestrian desire lines, and generally closer to the carriageway than to buildings.
- ▣ Cycle parking should be provided at bus and train stations to assist transition between transport modes.
- ▣ Cycle parking should be detectable by blind or partially sighted people.



Cycle parking that has good surveillance and is at a key location – in this example near a hospital entrance

Andrew Cameron WSP

Further guidance on the design of cycling facilities is provided in *LTN 2/08 Cycle Infrastructure design*.<sup>19</sup>

### Car parking

The Scottish Government's general planning policy for car parking is set out in the Transport section of the *Scottish Planning Policy (SPP)*<sup>20</sup>. This makes it clear that it is important to consider a design-led approach to the provision of car parking space that is well-integrated with a high-quality public realm. A design-led and contextual strategy for car parking can often lessen the impact on the built environment. Car parking can be provided in a number of ways as set out over the following pages.

## ▸ On-street parking

On-street parking in residential streets can help to reduce traffic speeds. This kind of parking can be counted towards the overall provision required in new developments, both for residents and visitors. Parking on adopted roads cannot be allocated to individual properties, but is a common resource.

In the past, on-street parking bays have been rigidly defined, creating an artificial constraint on street layout. More informal parking arrangements are to be encouraged, such as the use of subtle widening within a street or by using end-on or angled parking within a square. Trees, planting or street furniture can be used to discourage indiscriminate parking in an attractive way. Parking violations, however, cannot be acted upon without Traffic Regulation Orders, with traffic signs and road markings to indicate the restrictions in place.

An arrangement of parking bays adjacent to the running lanes is often the preferred way of providing on-street parking. It is recommended that, in most circumstances, at least some parking demand in residential and mixed-use areas is met with well-designed on-street parking:

Breaking up the visual impact can sometimes be achieved by limiting on-street parking to small groups of around five spaces.

In deciding how much on-street parking is appropriate, it is recommended that the positive and negative effects listed in the 'On-street parking' box are considered.

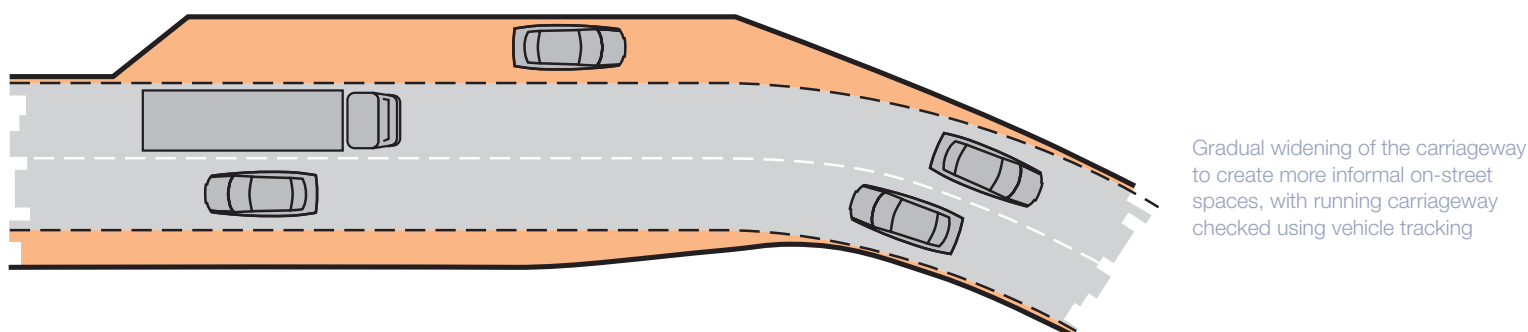

### On-street parking: positive and negative effects

The positive effects of on-street parking are that it:

- provides a common resource, catering for vehicles used by residents, visitors and service providers in an efficient manner;
- is able to cater for peak demands from various users at different times of the day, for example people at work or residents;
- adds activity to the street and slows traffic;
- is typically well overlooked, providing improved security;
- is popular and likely to be well-used;
- can provide a useful buffer between pedestrians and traffic; and
- potentially allows the creation of areas within perimeter blocks that are free of cars.

The negative effects of on-street parking are that it:

- can be visually dominant within a street scene and can undermine the established character;
- may lead to footway parking unless the street is properly designed to accommodate parked vehicles;
- can be dangerous and intimidating for cyclists, due to car doors opening and cars moving in and out; and
- can impair the social and play function of shared spaces if it is overly dominant.

In most situations, it will not be necessary to provide parking spaces specifically for service vehicles, such as delivery vans, which are normally stationary for a relatively short time.

### ▶ Off-street parking

Off-street parking will be required in many developments, whether on the house plot, in rear courtyards or in underground structures. On-plot parking should be designed so that the front garden is not overly dominated by the parking space.

Off-street parking includes off-street courtyards and rear courtyards, and the key principles are that that they:

- ▶ are not car parks but places which have parking in them;
- ▶ should be overlooked by adjoining houses or by buildings entered from the parking area; and
- ▶ should normally include, at most, 10 parking spaces. If there are more spaces, the courtyard layout should be broken up.

Where spaces are allocated in shared areas, these may not be adopted and do not constitute roads under the *Roads (Scotland) Act 1984*. Alternative arrangements for the future maintenance of these areas will need to be found, whether by a factor or through other agencies.

Care must be taken to ensure good natural surveillance in any off-street parking areas. Vehicular accesses to any off-street parking areas will need to be taken into account within the overall street design.

### ▶ Basement or undercroft parking

The advantage of putting cars underground is that it preserves the street frontage, uses land more efficiently and may be more convenient for drivers accessing the building, particularly in adverse weather. However, as with courtyard parking, much depends on the location and design of the entrance. Careful consideration should be given to the visual impact of undercroft parking at street level.

### ▶ On-plot parking

Parking within the front curtilage should generally be avoided as it breaks up the frontage, can be unsightly and restricts informal surveillance. On-plot parking may be suitable in restricted situations when integrated with other parking solutions and when considered in terms of the overall street profile.

### ▶ Garages

Garages are not always used for car parking and this can create additional demand for on-street parking. Car ports are a good alternative. Dimensions for garages should be sufficient to recognise current vehicle sizes in order to encourage their use for car storage.

### ▶ Parking spaces for disabled people

It is recommended that parking bays for disabled people are designed so that drivers and passengers, either of whom may be disabled, can get in and out of the car easily. They should allow wheelchair users to gain access from the side and the rear. The bays should be large enough to protect people from moving traffic when they cannot get in or out of their car on the footway side. Dropped kerbs should be conveniently sited to enable drivers who use wheelchairs to gain easy access to footways. Further information is contained in *PAN 78 Inclusive Design*.

*Car Parking; What Works Where*<sup>21</sup> provides a comprehensive toolkit for designers that gives useful advice on the most appropriate forms of car parking relevant to different types of residential development. Consideration should also be given to the *Safer Parking Scheme* initiative of the Association of Chief Police Officers (ACPO) and aimed at reducing crime and the fear of crime in parking areas. *PAN 77 Designing Safer Places*<sup>22</sup> also discusses this issue.



Parking courts should be considered as positive places

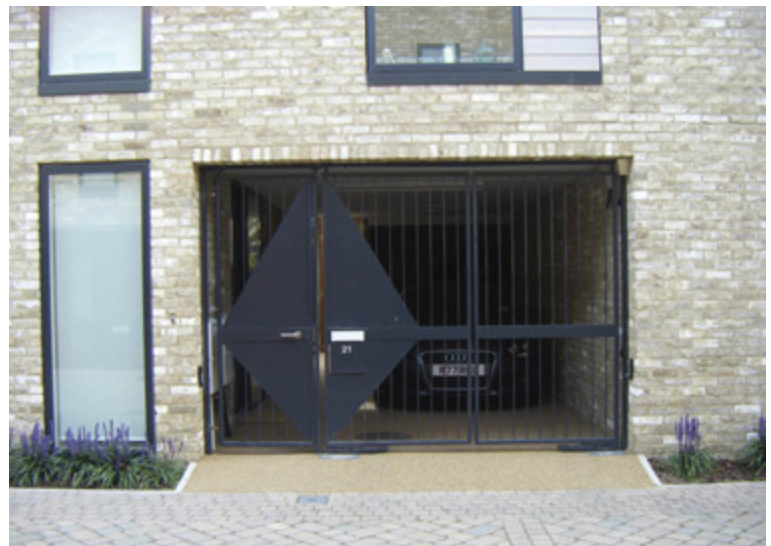

Discreet undercroft parking

Karen Esslemont



## Motorcycle parking

In planning for private residential parking, in most situations motorcycles will be able to use car parking spaces, but in some situations it will be appropriate to provide designated motorcycle parking areas. Guidance on motorcycle parking is contained in *Traffic Advisory Leaflet 02/02*.<sup>23</sup> General advice on designing streets to meet the need of motorcycles is given in the *Guidelines for Motorcycling*.<sup>24</sup> To estimate the space required for parking motorcycles, it is recommended that a 2.0 m by 0.8 m footprint is allowed per motorcycle.

## Dimensions for car parking spaces and manoeuvring space

For parking parallel to the street, each vehicle will typically need an area of about 2 m wide and 6 m long.

For echelon or perpendicular parking, individual bays will need to be indicated or marked. The rectangular bay area should be sized as follows:

- ▶ Absolute minimum of 2.4 m wide by 4.8 m long
- ▶ Desirable 2.5 m wide by 5.0 m long

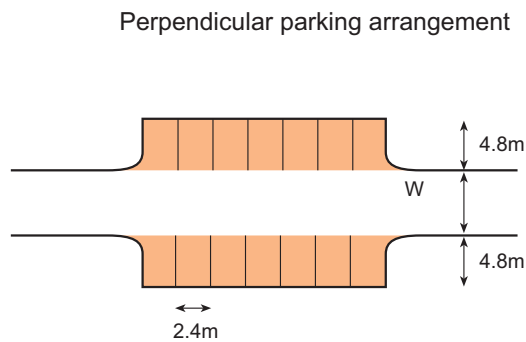
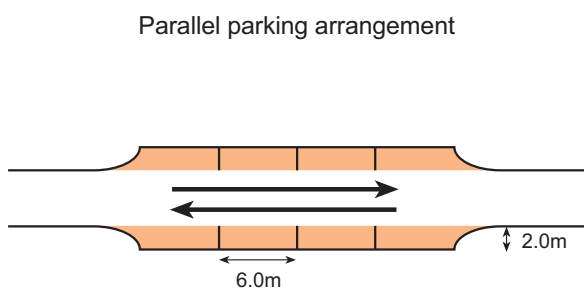

Suggested parallel and perpendicular parking arrangements

The width ( $W$  above) needed to access echelon or perpendicular spaces conveniently, depends on the width of the bay and the angle of approach. For a 2.4 m wide bay, these values are typically:

- ▶ at 90 degrees,  $W = 6.0$  m;
- ▶ at 60 degrees,  $W = 4.2$  m; and
- ▶ at 45 degrees,  $W = 3.6$  m.

The width requirements can be reduced if the spaces are made wider. Swept-path analysis can be used to assess the effect of wider spaces on reducing the need for manoeuvring space, as illustrated in the diagrams below.

Where space is limited, it may not be possible to provide for vehicles to get into the spaces in one movement. Some back and fore manoeuvring may be required. This is likely to be acceptable where traffic volumes and speeds are low.

## Other parking issues

Other issues for the design team and local authority to consider include:

- ▶ the appropriate level of car parking provision including the level of provision for disabled people (Blue Badge Holders);
- ▶ the negative impacts of conversion of front gardens to parking and parking in conservation areas;
- ▶ provision below normal demand (Lower levels can work successfully when adequate on-street parking controls are present and where it is possible for residents to reach day-to-day destinations, such as jobs, schools and shops, without the use of a car.);
- ▶ the potential for the use of car clubs which provide neighbourhood-based short-term car hire to members;
- ▶ unallocated parking (Not all parking spaces need to be allocated to individual properties. Unallocated parking provides a common resource for a neighbourhood or a specific development.); and
- ▶ the hazards and inconvenience to pedestrians caused by footway parking (It is therefore recommended that footway parking be minimised through the design of the street.).

## Tracking assessment

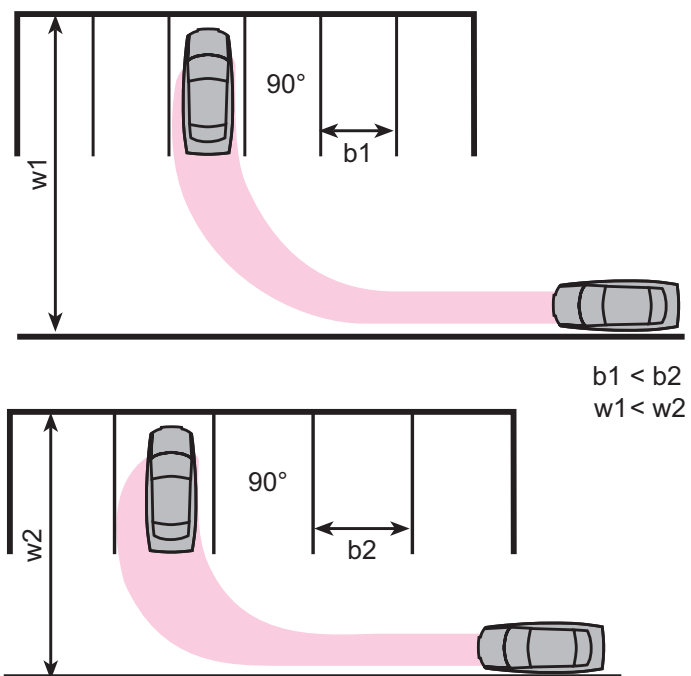

The effect on overall street width requirements when wider car parking spaces are provided

## Emergency and service vehicles

### Key considerations

- ▣ **Street layouts should accommodate emergency and service vehicles without compromising a positive sense of place**

### Emergency vehicles

The requirements for emergency vehicles are generally dictated by the fire service requirements. All development proposals should be discussed with the relevant Fire Authorities.

The Association of Chief Fire Officers has expanded upon and clarified these requirements as follows:

- ▣ A 3.7 m carriageway (kerb to kerb) is required for operating space at the scene of a fire. Simply to reach a fire, the access route could be reduced to 2.75 m over short distances, provided the pump appliance can get to within 45 m of all points within a dwelling.
- ▣ If an authority or developer wishes to reduce the running carriageway width to below 3.7 m, they should consult the local Fire Safety Officer.

### Service vehicles

The design of streets should accommodate service vehicles without allowing their requirements to dominate the layout.

On streets with low traffic flows and speeds, it may be assumed that vehicles will be able to use the full width of the carriageway to manoeuvre. Larger vehicles which are only expected to use a street infrequently, such as pantechinons, need not be fully accommodated – designers could assume that they will have to reverse or undertake multi-point turns to turn around for the relatively small number of times they will require access. The involvement of the local authority in determining design solutions for service vehicles is important.

Well-connected street networks have significant advantages for service vehicles. A shorter route can be used to cover a given area, and reversing may be avoided altogether.

### Waste collection vehicles

It is essential that liaison between the designers, the waste, roads, planning and building control authorities, and access officers, takes place at an early stage.

Planning authorities should ensure that new developments make sufficient provision for waste management and recycling and should promote designs and layouts that secure the integration of waste management facilities without adverse impact on the street scene.

Policy for local and regional waste planning bodies is set out in *Scottish Planning Policy*.

Routing for waste vehicles should be determined at the concept masterplan or scheme design stage. Wherever possible, routing should be configured so that the refuse collection can be made without the need for the vehicle having to reverse, as turning areas may be obstructed by parked vehicles.

While it is always possible to design new streets to take the largest vehicle that could be manufactured, this would conflict with the desire to create quality places. It is neither necessary nor desirable to design new streets to accommodate larger waste collection vehicles than can be used within existing streets in the area.

Swept-path analysis can be used to assess layouts for accessibility. Where achieving these standards would undermine quality of place, alternative vehicle sizes and/or collection methods should be considered.

*BS 5906: 2005* recommends a maximum reversing distance for refuse vehicles of 12 m. Longer distances can be considered, but any reversing routes should be straight and free from obstacles or visual obstructions.

Section 3.25 of the *Scottish Building Standards (Domestic) Technical Handbook*<sup>25</sup> provides guidance on achieving the standards set in the *Building (Scotland) Regulations 2004*<sup>26</sup> with regard to solid waste storage and collection point. The collection point can be on-street or may be at another location defined by the waste authority. Key recommendations are that:

- ▶ residents should not be required to carry waste more than 30 m (excluding any vertical distance) to the storage point;
- ▶ waste collection vehicles should ideally be able to get to within 25 m of the storage point (although *BS 5906: 2005* recommends slightly shorter distances) and the gradient between the two should not exceed 1:12; and
- ▶ there should be a maximum of three steps for waste containers up to 250 litres, and none when larger containers are used (The Health and Safety Executive recommends that, ideally, there should be no steps to negotiate).

*BS 5906: 2005*<sup>27</sup> provides guidance and recommendations on good practice. The standard advises on dealing with typical weekly waste and recommends that the distance over which containers are transported by collectors should not normally exceed 15 m for two-wheeled containers, and 10 m for four-wheeled containers.



# Street detail

## Drainage

### Key considerations

- Streets should use appropriate SUDS techniques as relevant to the context in order to minimise environmental impacts

### Street drainage

The majority of streets are designed to accommodate the disposal of foul and surface water and this needs to be considered at an early stage in the design of street layouts. This includes consideration of foul drainage, surface water and Sustainable Urban Drainage Systems (SUDS).

### Foul drainage

This will normally take the form of drains around the curtilage of buildings which come under the *Building (Scotland) Regulations 2004* and sewers located in the street where the relevant guidance is found within *Sewers for Scotland*.<sup>28</sup>

The adoption process for sewers is set by Section 16 of the *Sewerage (Scotland) Act 1968*.<sup>29</sup> The Scottish Water document *Sewers for Scotland* is a guide to facilitate the procurement, design, maintenance and adoption of sewers by Scottish Water.

### Surface water drainage

The street provides a conduit for the storage or disposal of rainwater and, by its nature and its impact on the environment, the management of surface water runoff is a more complex matter than dealing with foul water. Sustainable drainage solutions adoptable by both local authorities and Scottish Water are set out in *The SUDS Manual*.<sup>30</sup> The emphasis is on the sustainable management of surface water, whereby conveyance is maintained between SUDS features in the traditional sense using pipework and open channels with SUDS features enhancing water quality, amenity and biodiversity, whilst controlling run-off quantity.

When considering the management of surface water, designers, developers and authorities need to take account of the *PAN 61: Planning and Sustainable Urban Drainage*,<sup>31</sup> Scottish Planning Policy, and the *Water Environment and Water Services (Scotland) Act 2003 (WEWS Act 2003)*.<sup>32</sup> *WEWS Act 2003* transposes the *Water Framework Directive*<sup>33</sup> to assess, protect and enhance water environments in Scotland, into national law. The *Water Environment (Controlled Activities) (Scotland) Regulations 2005 (CAR)*<sup>34</sup> have been introduced under *WEWS Act 2003* to allow regulatory controls on this matter.

The *Flood Risk Management (Scotland) Act 2009*<sup>35</sup> requires local authorities to assess and prepare maps of relevant bodies of water and SUDS which will assist in the preparation of flood risk management plans by each local authority.



Land Use Consultants

The planning and management of surface water discharge from buildings and roads requires a co-ordinated approach to evaluating flood risk and developing an integrated urban drainage strategy.

The responsibility for undertaking site specific flood risk assessments in new developments (FRA) rests with the developer. However, *Scottish Planning Policy* advocates a partnership approach, consulting with the relevant stakeholders to compile the FRA. This will involve the local authority as flood authority, the Scottish Environmental Protection Agency (SEPA) and Scottish Water.

*Sewers for Scotland* recommends, and some local authorities require, that drainage criteria for new development comply with the drainage assessment requirements set out in *Drainage Assessment – A Guide for Scotland*.<sup>36</sup>

## Sustainable Urban Drainage Systems

The term Sustainable Urban Drainage Systems covers the whole range of sustainable approaches to surface water drainage management. SUDS aim to mimic natural drainage processes and remove pollutants from urban run-off at source. SUDS comprise a wide range of techniques, including permeable paving, swales, detention basins, filter strips, filter drains, infiltration systems, bio-retention, ponds and wetlands. To realise the greatest improvement in water quality amenity and biodiversity and flood risk management, these components should be used in combination, sometimes referred to as the SUDS Management Train, as described in *The SUDS Manual*.

SUDS are more sustainable than conventional drainage methods because they:

- ▶ manage run-off flow rates, using infiltration and the retention of storm water;
- ▶ protect or enhance the water quality;
- ▶ are sympathetic to the environmental setting and the needs of the local community;
- ▶ provide a habitat for wildlife in urban watercourses;
- ▶ encourage natural groundwater recharge (where appropriate); and
- ▶ can assist in reduction or removal of drainage network constraints.

They do this by:

- ▶ dealing with run-off close to where the rain falls (source control);
- ▶ managing pollution at its source; and
- ▶ protecting water resources from pollution created by accidental spills or other sources.

The use of SUDS is seen as a primary objective by the Government and should be applied wherever practical and technically feasible. Granting of planning permission will be dependent on agreement between the local planning authority and SEPA, as statutory consultees. It is a SEPA requirement that sufficient levels of SUDS are provided.

New guidance, *SUDS for Roads*,<sup>37</sup> has been developed by the SUDS Working Party, including representatives of SEPA, Scottish Water and local authorities, regarding acceptable forms of SUDS to be applied to roads.

Detailed guidance on the selection and design of SUDS is contained in *The SUDS Manual*, *Sewers for Scotland* and *SUDS for Roads*. All stakeholders need to be aware of the importance of the application of SUDS as part of an integrated urban drainage strategy for a development.



Andrew Cameron, WSP

## Utilities

### Key considerations

#### ❑ The accommodation of services should not determine the layout of streets or footways

Utilities are an essential component of street infrastructure and can have an important effect on layout issues, such as footway widths. The accommodation of utilities must not, however, compromise the creation of a sense of place or influence the design disproportionately. It is essential to liaise with the utility companies when the layouts of the buildings and streets are being designed.

Service strips should be designed to accommodate the services contained rather than by the application of rigid standards.

The availability and location of existing services should be identified at the outset. Where possible, all utility apparatus should be laid in 'corridors' throughout the site. This will facilitate the installation of the services and any future connections as the development proceeds.

Most residential streets provide routes for statutory undertakers and other services. Detailed advice on providing for utilities in new developments can be found in *NJUG Guidance*<sup>38</sup> and local authority guidelines.



Andrew Cameron WSP

An image of a layout driven by standards and formulaic solutions – the use of large radius bends, overly-dominant lighting columns, large building setbacks, inefficient land use, and inappropriate traffic calming contribute nothing to a positive sense of place



## Planting

### Key considerations

#### ▣ Street design should aim to integrate natural landscape features and foster positive biodiversity

Intelligent and appropriate planting in street design is encouraged. Planting, particularly street trees, helps to soften the street scene while creating visual interest, improving microclimate and providing valuable habitats for wildlife. Whilst appropriate driver sightlines should be maintained, vegetation can be used to limit excessive forward visibility to limit traffic speeds.

Care should be taken to preserve existing trees, particularly when changes to a street are planned. Consideration should also be given to the relationship of streets to existing and new green networks. Green networks can often provide pedestrian or cycle routes that offer increased connectivity and add a distinctive character area for people to enjoy.

Careful consideration needs to be given to appropriate tree selection, their location and how they are planted. Detailed advice on this issue is contained in the Communities and Local Government document, *Tree Roots in the Built Environment*.<sup>39</sup>

If possible, semi-mature trees should be planted. Slow-growing species with narrow trunks and canopies above 2 m should be considered.

Maintenance arrangements for all planted areas need to be established at an early stage, as they affect the design, including the choice of species and their locations. The approval and maintenance of proposed planting within the street boundary will be required to comply with Sections 50 and 51 of the *Roads (Scotland) Act 1984*.<sup>40</sup>

Alternatives to formal adoption may require innovative arrangements to secure long-term management of planting. These may include the careful design of ownership boundaries, the use of covenants and annual service charges on new properties.



Karen Esslemont EDAW

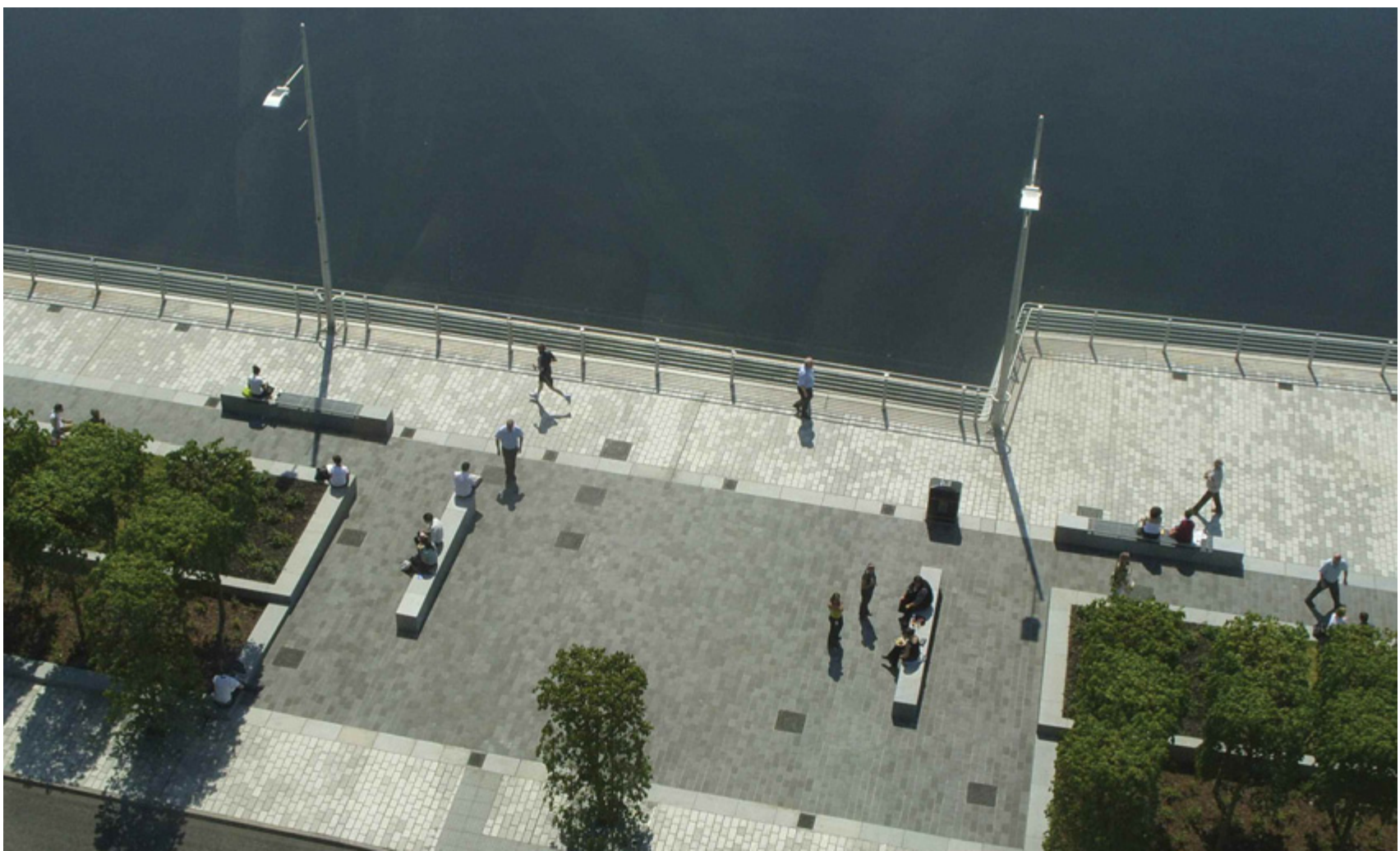

Atkins



## Materials

### Key considerations

- ▣ **Materials should be distinctive, easily maintained, provide durability and be of a standard and quality to appeal visually within the specific context**

### Materials and construction

Places need to look good and work well in the long term. Design costs are only a small percentage of the overall costs, but it is the quality of the design that makes the difference in creating places that will stand the test of time. Well-designed places last longer and are easier to maintain, thus the costs of the design element are repaid over time. The specification for materials and maintenance regimes should be written to provide high standards of durability and environmental performance. Maintenance should be straightforward and management regimes should ensure that there are clear lines of responsibility. The long term success of places can be as dependent on visual appeal as durability. The quality of the design and its appropriateness to an area can have a significant effect on the extent to which a place is liked and well-used.

Local authorities should be prepared to allow the use of alternative materials, landscaping treatments and features to those normally approved if they will help to create a positive sense of place and enhance context.

It is recommended that all materials:

- ▣ are easy to maintain;
- ▣ are safe for purpose;
- ▣ are durable;
- ▣ are sustainable (including the manufacturing process and energy use);
- ▣ are appropriate to the context; and
- ▣ provide clear street definition and hierarchy.

### Arrangements for future maintenance

It is important that decisions on the future maintenance arrangements of the streets and public spaces in a development are made early in the design process. If the streets are to be adopted by the local roads authority, the layout and material choices must be acceptable to the authority.

It is possible for streets to remain private but, ideally, a properly-constituted body with defined legal responsibilities will need to be established to maintain the streets to the common benefit of residents.

A road authority will require legal certainty that the streets are going to be properly maintained in perpetuity by these private arrangements. Approval for construction of new private streets will be required under Sections 17 and/or 21 of the *Roads (Scotland) Act 1984* and, under Section 13 of this Act, the local roads authority has powers to require a private road is maintained to a reasonable standard (as set by the authority).

A roads authority may be unwilling to adopt items such as planting and street furniture (e.g. play equipment and public art) which are not considered to relate to the movement functions of the street. If there is no private management company, arrangements can be made for such features to be maintained by another local authority department.



Gillespies and Paul Zanre

## Reducing clutter

### Key considerations

- ❑ Signs and street markings should be kept to a minimum and considered early in the design process
- ❑ Street lighting should be as discreet as possible, but provide adequate illumination
- ❑ Street furniture should be located for maximum benefit and to reduce pedestrian obstruction

### Traffic signs

The *Traffic Signs Regulations and General Directions 2002*<sup>41</sup> (TSRGD), is a regulatory document which details every traffic sign prescribed for use in the UK. It includes all of the prescribed road markings, as a road marking is legally a sign. *TSRGD* also stipulates the conditions under which each sign may be used.

Further advice on the use of signs is contained in the *Traffic Signs Manual*,<sup>42</sup> which gives advice on the application of traffic signs in common situations. Compliance with *TSRGD* is mandatory. The *Traffic Signs Manual* is guidance and there is therefore scope for moving away from its recommendations if justified by local circumstances.

### The requirement for signs

No sign is fundamentally required by *TSRGD* per se. Signs are only needed to warn or inform, or to give effect to Traffic Regulation Orders (TROs) and *TSRGD* simply sets out how signs must be used once it has been decided that they are necessary.

Signs are most effective when used sparingly. Designers should ensure that each sign is necessary – they should use the flexibility within the *TSRGD* and associated guidance documents to ensure that signs are provided as required, but do not dominate the visual appearance of streets.

The non-provision of signs and markings may be appropriate in lightly-trafficked environments specifically designed to promote low speeds. It reduces clutter and the relative lack of signage may also itself encourage lower vehicle speeds.

Signs which have no clear purpose should be removed to reduce clutter and to ensure that essential messages are prominent. Although much signage is provided for the benefit of motorised users, it is generally located on the footway and can contribute to clutter.

In the case of new developments, some road authorities seek to guard against having to install additional signs at their own expense later, by requiring all manner of signs to be provided by the developer at the outset. This will lead to clutter and is not recommended. The preferred way of addressing such concerns is to issue a bond to cover an agreed period, so that additional signs, if deemed absolutely necessary, can be installed later at the developer's expense if required.



Inappropriate signage



Overly dominant signage that detracts from the place



It is desirable to limit the number of posts in footways. Where possible, signs should be attached to adjacent walls, not more than 2 m from the edge of the carriageway, or be grouped on posts.

Existing streets should be subject to a signs audit to ensure that they are not over-signed and, in particular, that old, redundant signs have been removed.

The use of centre lines is not an absolute requirement. There is some evidence that, in appropriate circumstances, the absence of white lines can encourage drivers to drive at lower speeds.

Most unsignalised junctions are designed assuming a dominant flow, with priority indicated by give-way signs and markings. There is no statutory requirement for junction priority to be specified. Unmarked junctions that require drivers to 'negotiate' their way through may be appropriate on lower volume streets, as this can help to control speeds.

### Street furniture

Every piece of street furniture should earn its place in the street.

Street furniture should have a clear function and should not be regarded as simple ornamentation. Street furniture should be integrated into the overall design of a street and relate to context.

Street furniture that encourages human activity can also contribute to a sense of place. The most obvious example of this is seating, or features that can act as secondary seating such as low walls or planters. Wherever possible, street furniture should perform more than one function in the interests of reducing clutter and improving amenity.

Seating is necessary to provide rest points for pedestrians, particularly older people or people with mobility or visual impairments, and extra seating should be considered where people congregate, such as squares, local shops and schools. Guidance is given in *PAN 78 Inclusive Design and BS 8300*.<sup>43</sup> Seating can sometimes attract anti-social behaviour and therefore should be located where there is good lighting and natural surveillance.

### Guard railing

Guard railing should not be provided unless a clear need for it has been identified. Introducing measures to reduce traffic flows and speeds may be helpful in removing the need for guard railing. In most cases, it is unlikely that guard railing will be required on residential streets.



As well as being visually intrusive, the inappropriate use of guard railings can block pedestrian desire lines, with consequential possible dangers

Andrew Cameron WSP

## Lighting

Where streets are to be lit, lighting should be planned as an integral part of the design of the street layout at an early stage. Lighting should illuminate both the carriageway and the footway.

Consideration should be given to attaching lighting units to buildings to reduce street clutter. Under Section 35 (5) of the *Roads (Scotland) Act*, local authorities have the power to fix lighting to walls and buildings, subject to a statutory consultation with involved parties and a specified notice period.

Lighting should be appropriate and sympathetic to the context. A street lighting assessment can be helpful in determining both the level of lighting and the type of equipment used in the area.

In street design, consideration should be given to the purpose of lighting, the scale of lighting relative to human users of the street, the width of the street and the height of surrounding buildings.

Where road and pedestrian area lighting are both required, some road authorities install lamp columns featuring a secondary footway light mounted at a lower height. This can assist in illuminating pedestrian areas well, particularly where footways are wide or shaded by trees.

The colour of lighting is another important consideration. This relates both to people's ability to discern colour under artificial light and the colour 'temperature' of the light. Light colour temperature is a consequence of the composition of the light, ranging simply from blue (cold) to red (warm). Generally, pedestrians prefer whiter lighting.

Lighting should generally be in accordance with *BS EN 13201-2*,<sup>44</sup> *BS EN 13201-3*,<sup>45</sup> and *BS EN 13201-4*.<sup>46</sup> Guidance on lighting design is given in *BS 5489-1, Code of Practice for the Design of Road Lighting*,<sup>47</sup> to comply with the requirements of *BS EN 13201*. This is a guidance document only and local circumstances may require different approaches.

Further guidance is contained within *Controlling Light Pollution and Reducing Lighting Energy Consumption*,<sup>48</sup> *PAN 51: Planning, Environmental Protection and Regulation*<sup>49</sup> and *PAN 77: Designing Safer Places*.



Building-mounted lighting

Andrew Cameron WSP



# How to achieve better outcomes





### How to achieve better outcomes

*Designing Streets* recognises that good design requires to be supported by an informed process. The large number of stakeholders involved in street design demands that the overlaps between professionals, decision makers and the public are fully integrated and work in a collaborative way.

## policies

- ▶ Street design should be based on balanced decision-making and must adopt a multidisciplinary collaborative approach
- ▶ Street design should run planning permission and Road Construction Consent (RCC) processes in parallel

### Joint working processes

Street design involves a wide range of contributors and it is essential that these individuals and organisations work together from the earliest point towards a common objective – the delivery of distinctive streets where functionality is accommodated within a positive sense of place.

It is important for the various parts of local authorities to work together when giving input to a development proposal. Developers may be faced with conflicting requirements if different parts of local authorities fail to coordinate their input. This can cause delay and a loss of design quality. This is particularly problematic when one section of a local authority – for example the roads adoption/Roads Construction Consent (RCC) or maintenance engineers – become involved late in the process and require significant changes to the design. A collaborative process of partnership and cooperation is required from the outset between all relevant parties.

Similarly, it is vital that developer teams also work in an integrated manner to deliver quality street design and provide appropriate interfaces with local authorities and other stakeholders. Engagement with agencies is encouraged as early as possible, preferably at pre-application stage. Detailed policy issues must be addressed as early in the process as possible in order to integrate solutions and streamline processes.

Ongoing dialogue between all parties – developer teams, authorities, agencies, the public including disability groups and access panels – is essential.



John Thompson & Partners

# Case study

## PARC Craigmillar, Edinburgh

PARC Craigmillar is a joint venture company between the EDI Group Ltd and the City of Edinburgh Council. Together with groups and representatives from the Craigmillar community, the Company works on the regeneration of the Craigmillar area in Edinburgh.

Central to the regeneration project is the innovative approach to street design. The project contains successful Shared Space/ Home Zone areas and level surfaces that link the residential streets and new primary schools campus, providing an area in which vehicle movement is secondary to the activity of pedestrians.

Much of the Shared Space area is constructed with permeable paving, which integrates drainage functions within the on-street parking bays and carriageway build-up. The design of the carriageway was undertaken in a collaborative process with the City of Edinburgh Council, to a standard that allowed the Council to adopt the streets including the areas of permeable paving. Careful and efficient incorporation of underground utilities and services was paramount to ensure the successful design of these streets.

PARC Craigmillar's Shared Space development at Wauchope Square has been nationally recognised - winning the best Home Zone category in the UK Street Design awards 2009, awarded by Local Government News.

The work at Craigmillar illustrates how many of the functions of streets can be integrated in both innovative designs and collaborative processes that result in streets with a distinctive and positive character and excellent functionality.



Keith Hunter



Keith Hunter

## Joint planning permission & RCC processes

Research carried out for the Scottish Government in 2005 identified ways in which the Roads Construction Consent process could be better integrated with the planning approval process. This process has now been updated accordingly, and will provide greater certainty for developers taking forward more innovative designs and meet government objectives for streamlining the planning process. The chart below illustrates a method to follow to comply with the national policy on this matter.

### Residential street approval process

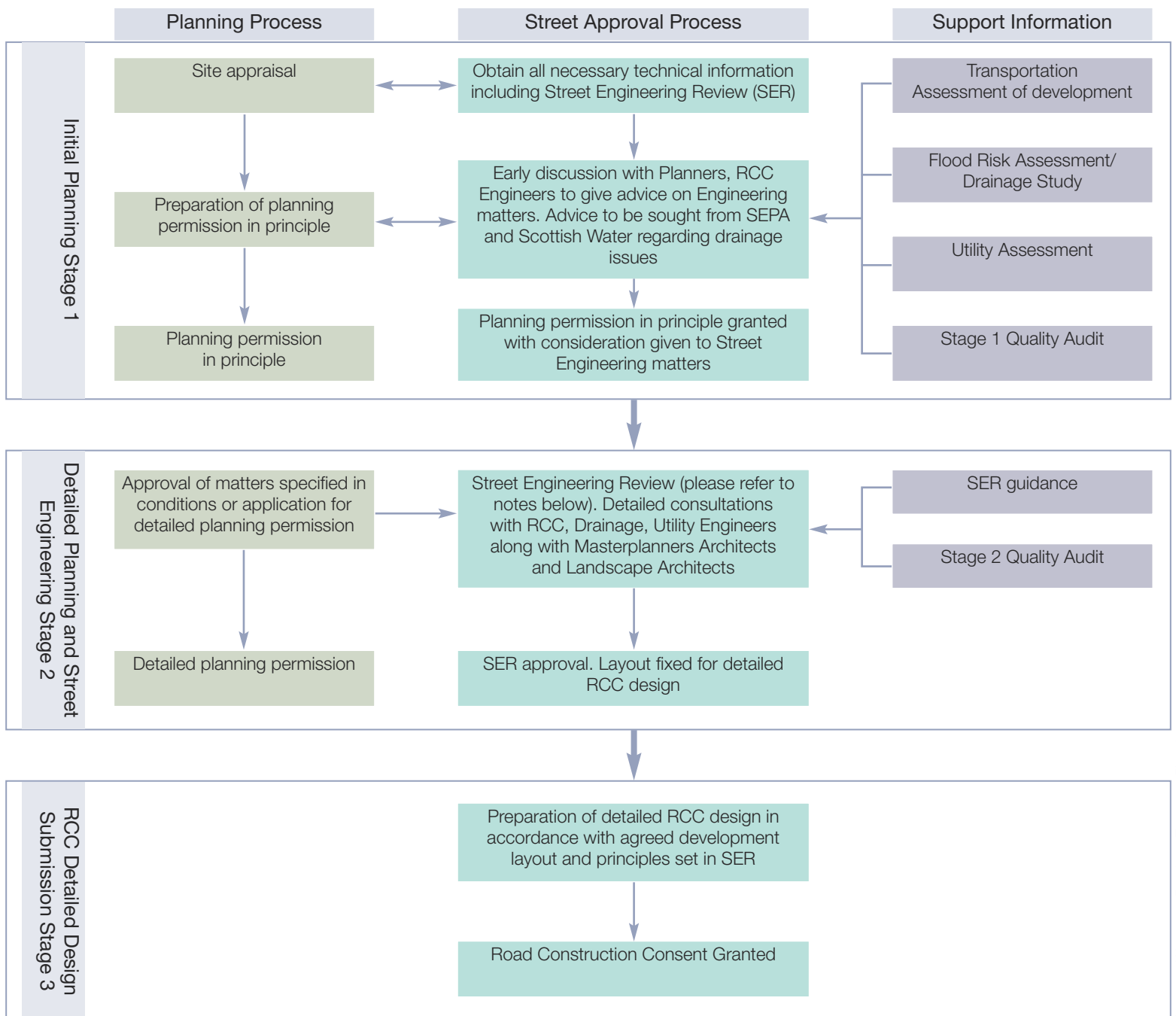

### Street Engineering Review (SER) Notes

Undertake SER in accordance with Local Authority guidance and relevant national policy/guidance (e.g. *Designing Streets*).

SER to include areas such as:

- ▣ Agreement of street layout including landscaping proposals in relation to the following:
  - Vehicle tracking of layout (particular attention to be given to refuse vehicles and buses)
  - Approval of key visibility splays
  - Speed control
  - Agreement of drainage discharge rates
  - Agreement of SUDS techniques
  - Schematic drainage layout for foul and surface water including dimension requirements against building and landscaping
  - Key materials palette
  - Utilities strategy

In some instances, insufficient detail may exist at planning permission in principle stage to justify RCC processes to take place. Balanced decisions on individual applications are required.



## Quality Audits

The Quality Audit process aims to allow for more innovative design solutions where over safety-cautious practices can be omitted in favour of creating places that are high quality and enjoyable to use.

A Quality Audit draws together assessments by various professionals, and each may be undertaken within particular guidelines. By grouping the assessments together, any compromises in the design will be apparent, making it easier for decision makers to view the scheme in the round.

Quality Audits can ensure that street designs are appropriate and meet the objectives agreed at the outset. Documented audit and sign-off systems also provide a strong defence against any liability claims that may arise after the scheme has been implemented.

Quality Audits are particularly beneficial in the following circumstances:

- ▶ at option testing stage;
- ▶ at pre-application stage;
- ▶ where strong tensions exist between different objectives, a Quality Audit will aid more balanced decision-making;
- ▶ for schemes within existing streets, where a quality audit will provide an opportunity for decision-makers to make a balanced assessment of different considerations before approving a particular solution; and
- ▶ for smaller schemes where no Design Statement will be required.

The audit may include documents required by the local planning authority to support an application.

A Quality Audit should be integral to the design and implementation and not a tick box exercise. A typical audit may include some of the following assessments but the content will depend on the type of scheme and the objectives which the scheme is seeking to meet:

- ▶ an audit of visual quality
- ▶ a review of how the street will be used by the community
- ▶ a Road Safety Audit
- ▶ an inclusive access audit
- ▶ a walking audit
- ▶ a cycle audit

## Road Safety Audits (RSA)

The purpose of the RSA is to identify potential road safety problems. Road Safety Audits can be a key component within an overall Quality Audit. Road Safety Audits are routinely carried out for many road schemes. The Institution of Highway and Transportation (IHT) Guidelines on RSA sit alongside the relevant standard contained in *DMRB* as the recognised industry standard documents in the UK. The procedures set out in *DMRB*, however, are a formal requirement for trunk roads only.

It is important to understand that RSAs are not mandatory for local road authorities. Many residential streets, where the design is carried out by a developer's consultant, are assessed independently by the local roads authority. In many authorities, there is no requirement for a further check by a Roads Safety Audit team, particularly where it is clear that motorised traffic volumes and speeds, and the degree of potential conflict between different user-groups, is not going to be significant.

An RSA is not a check on compliance with design standards. Audits should take all road users into account, including pedestrians and cyclists. The auditor reviews the proposals and the local authority decides whether or not to accept particular recommendations.

It is also important to note that the design team retains responsibility for the scheme and is not governed by the findings of the report. There is, therefore, no sense in which the scheme passes or fails the RSA process. Designers do not have to comply with the recommendations of a Safety Audit although, in such cases, they would be expected to justify their reasoning within a written report.

The process set out in *DMRB* requires the audit team to be independent of the design team, and road safety issues are therefore often considered in isolation from visual quality and successful place-making issues. It can therefore be difficult to achieve a balanced design through dialogue and compromise. The requirement for independence need not, however, prevent contact between the design team and the audit team throughout the process.

The involvement of road safety professionals as an integral part of the design team is recommended to help to overcome problems. This allows ideas to be tested and considered in more balanced and creative ways, and should overcome situations where perceived safety issues lead to late changes to schemes, often to the detriment of design quality.

Another area of concern with the current system is that RSAs may seek to identify all possible risks without distinguishing between major and minor risks, or quantifying the probability of them taking place. There can also be a tendency for auditors to encourage designs that achieve safety through segregating vulnerable road users from road traffic. Such designs can perform poorly in terms of streetscape quality, pedestrian amenity and security and, in some circumstances, can actually reduce safety levels.

It would therefore be useful if RSAs included an assessment of the relative significance of any potential safety problems. A risk assessment to consider the severity of a safety problem and the likelihood of occurrence would make it considerably easier for decision-makers to strike an appropriate balance. An example of a risk assessment framework is given in *Highway Risk and Liability Claims*.<sup>50</sup>



## Conclusion

Good street design impacts upon a wide variety of issues, and it is, thus, essential for all those involved in designing streets to work productively to achieve the goals of this policy document.

The design rationale, processes and justification for a new approach to street design have been clearly laid out. It is, however, of central importance that individuals and organisations

adopt both the spirit and the detail of this policy and engage in a proactive manner.

The outcomes for all of those involved in street design are not simply designs, approvals or agreements: they are the delivery of new lively, vibrant and sustainable places of which Scotland can be proud for generations to come.





# Annex: Technical questions and answers

## What is the legal and technical context?

A complex set of legislation, policies and guidance applies to the design of streets. There is a tendency among some designers and approving authorities to treat design guidance as hard and fast rules because of the mistaken assumption that to do otherwise would be illegal or counter to a stringent policy. This approach is wrong. It restricts innovation, and leads to standardised streets with little sense of place or quality. In fact, there is considerable scope for designers and approving authorities to adopt a more flexible approach on many issues. It is, therefore, Scottish Government policy in *Designing Places* and *Designing Streets* to encourage street design which engenders place and quality.

By copying a standard example without due consideration, designers abrogate their own professionalism. When doing so, they still retain responsibility for the design, as it is their decision to copy a standard example which has been produced by individuals who may never have seen the site in question, and which may therefore not be suitable.

The following comprise the various tiers of instruction and advice:

- ▶ the legal framework of statutes, regulations and case law
- ▶ government policy
- ▶ government guidance
- ▶ local policies
- ▶ local guidance
- ▶ design standards
- ▶ evidence and research base and the concept of 'evidence-based design'

The Westminster and Scottish Parliaments and the Courts have established the legal framework. In this respect, certain aspects of transport are reserved to Westminster in terms of the *Scotland Act 1998*<sup>51</sup>. For example, this includes the provisions which are the subject matter of the *Road Traffic Act 1988*<sup>52</sup>, namely traffic signs and speed limits.

The Scottish Government develops policies aimed at meeting various objectives which roads and planning authorities are directed to follow. *Designing Places* and *Designing Streets* are such policies. It also issues supporting guidance to help authorities implement these policies, including the guidance in this document.

Evidence-based design has been developed as a concept within recent years. A distinction needs to be drawn between policies, guidance and practices that are, in essence, rule of thumb and that reflect simply a continuation of a conventional approach, and those that are based on science, statistics and designed experimental studies, and regularly challenged to ensure that they are relevant to modern needs and conditions. *Designing Streets* is supported by an evidence base.

Within this overall framework, road and planning authorities have considerable leeway to develop local policies and standards, and to make technical judgements with regard to how they are applied. Other bodies also produce advisory and research material on which they can draw.

## What is the risk and liability?

Concerns around risk and liability frequently lead to the rigid application of standards that can stifle design-led, contextual approaches. Roads authorities have often applied a very cautious approach in order to avoid potential liability in the event of damage or injury.

This over-cautious approach is ill-advised, and restricts innovation and responses to local context. Recent case law has established that drivers are primarily responsible for their own safety and although road authorities have a general duty under Section 39 of the Road Traffic Act 1988 to promote safety, this does not create a duty of care.

A major concern expressed by some road authorities when considering more innovative designs, or designs that are at variance with established practice, is whether they would incur a liability in the event of damage or injury.

This can lead to an over-cautious approach, where designers strictly comply with guidance regardless of its suitability, and to the detriment of innovation. This is not conducive to creating distinctive places that help to support thriving communities.

In fact, imaginative and context-specific design that does not rely on conventional standards can achieve high levels of safety. The design of Poundbury in Dorset, for example, did not comply fully with standards and guidance then extant, yet it has very few reported accidents. This issue was explored in some detail in the publication *Highway Risk and Liability Claims 2009*.

Claims against road authorities relate almost exclusively to alleged deficiencies in maintenance. Claims for design faults are extremely rare. The duty of the road authority to maintain the road is set out in the *Roads (Scotland) Act 1984*, and case law has clarified the law in this area.

The courts in Scotland have adopted a cautious approach when considering the duty of care potentially owed by roads authorities. Merely because a roads authority has powers, this does not generally open up the authority to liability. The circumstances in which roads authorities have been held liable in damages have been very restricted. The restrictive approach has also been adopted in circumstances where the risk of an accident may well be foreseeable. (See *Murray v Nicholls* and *Bennett v J Lamont & Sons*).



The Scottish line of authority has been recently reinforced by the House of Lords in the case of *Gorringe v. Calderdale MBC* (2004). A claim was made against a highway authority in England ('roads' authority in Scotland) for failing to maintain a 'SLOW' marking on the approach to a sharp crest. The judgement confirmed a number of important points which were that:

- ▶ the authority's duty to 'maintain' covers the fabric of a highway, but not signs and markings;
- ▶ there is no requirement for the road authority to 'give warning of obvious dangers' and natural road hazards; and
- ▶ drivers are 'first and foremost responsible for their own safety'.

A handful of claims for negligence and/or failure to carry out a statutory duty have been made under section 39 of the *Road Traffic Act 1988*, which places a general duty on road authorities to promote road safety. In connection with new roads, Section 39 (3)(c) states that road authorities 'in constructing new roads, must take such measures as appear to the authority to be appropriate to reduce the possibilities of such accidents when the roads come into use'.

The *Gorringe v. Calderdale* judgment made it clear that *Section 39 of the Road Traffic Act 1988* did not create a duty of care and, therefore, does not form the basis for a liability claim.

Advice to road authorities on managing their risks associated with new designs is given in Chapter 5 of *Highway Risk and Liability Claims (2009)*. In summary, this advises that authorities should put procedures in place that allow rational decisions to be made with the minimum of bureaucracy, and create an audit trail which could subsequently be used as evidence in court.

Suggested procedures include the following key steps:

- ▶ set clear and concise scheme objectives;
- ▶ work up the design against these objectives; and
- ▶ review the design against these objectives through a quality audit.

### Balanced decisions

A suggested framework from *Highway Risk and Liability Claims (2009)* which accords with those set out in *Designing Streets* is:

**Vision** – there should be an overall vision for an area that reflects local and national policy and, where appropriate, the views of the local community

**Objectives/Purpose** – there should be a robust understanding of what the scheme is intended to do. This will normally include balancing:

- ▶ movement and place;
- ▶ risk and opportunity; and
- ▶ ensuring sustainability.

**Design** – this should be worked up against the objectives

**Quality audit** – this is a review of the design against the objectives set

## What are the issues regarding disability discrimination?

Road and planning authorities must comply with the Disability Equality Duty under the *Disability Discrimination Act 2005*. This means that in their decisions and actions, authorities are required to have due regard to six principles, which are to:

- ▶ promote equality of opportunity between disabled persons and other persons;
- ▶ eliminate discrimination that is unlawful under the 2005 Act;
- ▶ eliminate harassment of disabled persons that is related to their disabilities;
- ▶ promote positive attitudes towards disabled persons;
- ▶ encourage participation by disabled persons in public life; and
- ▶ take steps to take account of disabled persons' disabilities, even where that involves treating disabled persons more favourably than other persons.

Those who fail to observe these requirements will be at the risk of a claim. Not only is there an expectation of positive action, but the duty is retrospective and local authorities will be expected to take reasonable action to rectify occurrences of non-compliance in existing areas.

The Disability Rights Commission (DRC) has published a *Statutory Code of Practice on the Disability Equality Duty*<sup>53</sup> and it has also published specific guidance for those dealing with planning, buildings and the street environment.

## What are the adoption and maintenance issues?

### Key considerations

- ▶ The quality of the environment created by new development needs to be sustained long after the last property has been occupied. This requires good design and high-quality construction, followed by good management and maintenance.
- ▶ Authorities are encouraged to adopt a palette of suitable local and natural materials which allow for more creative design whilst being practical to maintain.
- ▶ Resource efficiency and sustainability should be addressed through the use of appropriate materials and systems including SUDS.
- ▶ The inclusion of planting (in particular street trees) is encouraged within the street environment.

### Roads adoption – legal framework

Provision of roads for new developments is controlled and consented by the local roads authority through the Roads Construction Consent (RCC) process, governed by Section 21 of the *Roads (Scotland) Act 1984*. For the purposes of adoption, all streets are deemed to be roads under this Act.

Under the terms of the RCC, having first secured technical approval of the designs from the local authority, the developer is obliged to construct roads over which there is a public right of passage to an agreed standard. Expenses will be payable by the developer to the roads authority to cover its reasonable costs in inspecting the construction of the works and associated testing.

*The Roads (Scotland) Act 1984* sets out the obligations of the developer to construct the roads and maintain them for a set period of normally 12 months. Following the satisfactory discharge of these obligations, the new roads can be offered to the roads authority for adoption. If the road is adopted, it will in the future be maintainable by the roads authority.

## Road Bond Security

Where Roads Construction Consent is granted relative to roads associated with housing development, the granting of the consent will require the deposit of sum or surety (Roads Bond) sufficient to meet the cost of constructing the road. The purpose of this bond is to enable the roads authority to meet the cost of constructing or completing the construction of the roads, should the developer fail in his responsibility to do so under the terms of the granted RCC.

Before any roads works commence on such a housing development, the developer will normally be required to have both the Roads Construction Consent and the Roads Bond in place.

Thus, before any construction begins, the developer will normally be required either:

- ▶ to secure the payment of the estimated cost of the road works under the requirements of the *Roads (Scotland) Act 1984*; or
- ▶ to make an agreement with the road authority under terms of the Act and provide a Bond of Surety.

## Private streets

Where a developer wishes streets to remain private, some roads authorities have incorporated conditions into the planning approval to require the developer to design, construct and to make arrangements for the future maintenance of the new streets to a standard acceptable to the authority. This agreement may still require the submission and approval of an RCC under the terms of Section 21 of the Act.

## Landscape features adoption

Maintenance arrangements for all planted areas should be established at an early stage, as they affect the design, including the choice of species and their locations. The approval and maintenance of proposed planting within the road boundary will be required to comply with Sections 50 and 51 of the *Roads (Scotland) Act 1984*.

Alternatives to formal adoption may require innovative arrangements to secure long-term landscape management. These may include the careful design of ownership boundaries, the use of covenants and annual service charges on new properties.

## What is adoptable?

The roads authority has considerable discretion in exercising its powers as to whether to grant a Roads Construction Consent under Section 21 of the Act.

A roads authority can be required to adopt a road constructed in accordance with an RCC. The streets put forward for adoption must be constructed to the agreed standard and will be subject to a 12 month period of use as a road whilst being maintained to the agreed standard by the developer.

Roads authorities have tended to only adopt streets that serve more than a particular number of individual dwellings or more than one commercial premises. Two to three dwellings is often set as the lower limit, but some authorities have set figures above this.

## Design standards for Road Construction Consent

Roads authorities are now encouraged to take a flexible approach to road adoption in order to allow greater scope for designs that respond to their surroundings and create a sense of place. It is recognised, however, that roads authorities will need to ensure that any future maintenance liability is kept within acceptable limits.

One way of enabling designers to achieve local distinctiveness without causing excessive maintenance costs will be for roads authorities to develop a limited palette of special materials and street furniture. Such materials and components, and their typical application, could, for example, be set out in local design guidance and be adopted as a planning policy.

Clear cases must be made where the adoption of designs are sought that differ substantially from those envisaged in a local authority's design guide or *Designing Streets*. Developers should produce well-reasoned design arguments in relation to this.

Roads authorities would normally be expected to adopt:

- ▶ residential streets, combined footways and cycle tracks;
- ▶ footways adjacent to carriageways and main footpaths serving residential areas;
- ▶ Home Zones and level surface streets;
- ▶ land within visibility splays at junctions and on bends (in some cases);
- ▶ street trees;
- ▶ any verges and planted areas adjacent to the carriageway;
- ▶ structures, i.e. retaining walls and embankments, which support the road or any other adoptable area;
- ▶ street lighting;
- ▶ gullies, gully connections and road drains and other road drainage features;
- ▶ on-street parking spaces adjacent to carriageways; and
- ▶ service strips adjacent to level surface streets.

## **Private management companies/factors**

Any unadopted communal areas will need to be managed and maintained through private arrangements. Typical areas maintained in this way include communal gardens, shared off-street car parking, shared cycle storage, communal refuse storage and composting facilities and sustainable energy infrastructure.

## **Approval processes for new streets**

The design and approval of new streets is governed by both planning and roads legislation. The design process must therefore recognise both sets of requirements. *The Roads (Scotland) Act 1984* is the primary legislation for new roads, and all new roads must receive RCC under Section 21 of that Act prior to construction. Previous practice applied by most local authorities dictates that the formal RCC approval process only starts with the granting of planning permission, or at least with the agreement of the final planning layout. The process thus results in a 2-stage (planning and roads) approval process that not only significantly extends the overall statutory approval process and delays commencement of development construction but, by more rigid application of engineering requirements at this 2nd stage, can lead to a dilution of overall design quality.

Street design requires an integrated approach to approval, involving collaboration between planning officers and RCC engineers. In this way, roads colleagues will be satisfied with the fundamentals of the development proposal, and can approve it in principle concurrent with the granting of planning permission. RCC engineers will have an important role to play as consultees in the planning application process. It is as a consultee that the roads authority can ensure that an appropriate 2-stage approach is adopted. The roads authority should be satisfied that sufficient information has been provided with the planning application to ensure that a subsequent RCC reflecting the design will not alter the details approved under the planning permission. These discussions should take place as early as possible – before a layout is worked up and a planning application submitted. It is important that any principles that have been agreed at this point in the design process are not revisited later, unless there has been a significant change in circumstances.

Planning policies should set the overall benchmark for the design quality of any new development, which includes the new streets as a key part of the public realm. This is why local authorities should have specific planning policies on street design ideally within the development plan, or as Supplementary Planning Guidance (SPG). Planners and road engineers should work together to ensure policies are up to date and allow for the most appropriate street patterns.

The flow chart contained in Part 3 of this document shows how a more integrated system should operate, and the key design decisions which would need to be taken, and signed off, at each stage.

## **Adoption of SUDS**

Adoption issues will need to be clarified at an early stage in the design process, with the likely adopting authorities; Scottish Water, local authority and potential private bodies. The amendments to Section 7 of the *Sewerage (Scotland) Act 1968* published within *SUDS for Roads*, focus on adoption of SUDS at a regional level by encouraging a collaborative approach to shared systems between local authorities and Scottish Water. It is important for a continuous, team-based approach to this matter.



## References

1. *Designing Places*: Scottish Executive 2001
2. *Planning Advice Note (PAN)76 Residential Streets*: Scottish Executive 2005
3. *Design Bulletin 32 (DB32) – Layout of Residential Roads and Footpaths*: Institution of Civil Engineers (ICE) 1977. DB32 was not published in Scotland, although it has been widely used by roads authorities as a basis for Scottish standards.
4. *Manual for Streets*: Department for Transport 2007 gives advice for the design of residential streets in England and Wales.
5. *Design Manual for Roads and Bridges (DMRB)*: The Highways Agency. The DMRB suite of documents is updated several times each year.
6. *Local Transport Note 2/08 Cycle Infrastructure Design*: Department for Transport 2008
7. *Disability Discrimination Act 2005*: The Stationery Office (TSO)
8. *Planning and Buildings Standards Advice Note (PAN)78, Inclusive Design*: Scottish Executive 2006
9. *Inclusive Mobility – A Guide to Best Practice on Access to Pedestrian and Transport Infrastructure*: Department for Transport 2002
10. *Disability Discrimination Act: Good Practice Guide for Roads*: Transport Scotland 2009
11. *TRL Report No. 332 – Road layout design standards and driver behaviour*: Transport Research Laboratory 1998
12. *TRL Report No. 661 – Manual for streets: evidence and research*: Transport Research Laboratory 2007
13. *Mini-roundabouts: Good Practice Guidelines*: Department for Transport 2006
14. *Transport (Scotland) Act 2001*: The Stationery Office (TSO)
15. *Home Zones; Challenging the future of our streets*: Department for Transport 2005
16. *Home Zone Design Guidelines*: Institute of Highway Incorporated Engineers (IHIE) 2002
17. *Shared Space Project Stage 1: Appraisal of Shared Space*: Department for Transport 2009
18. *Designing for Disabled People in Home Zones*: Disabled Persons Transport Advisory Committee (DPTAC) 2007
19. *Local Transport Note (LTN) 2/08 Cycle Infrastructure Design*: Department for Transport 2008
20. *Scottish Planning Policy (SPP)*: Scottish Government 2010
21. *Car Parking; What Works Where*: English Partnerships 2006
22. *Planning Advice Note (PAN) 77 Designing Safer Places*: Scottish Executive 2006
23. *Traffic Advisory Leaflet 02/02*: Department for Transport 2005
24. *Guidelines for Motorcycling*: Institute of Highway Incorporated Engineers (IHIE) 2005
25. *Scottish Building Standards Technical Handbooks*: The Stationery Office (TSO) (2004) revised 2007. These Technical Handbooks provide guidance on achieving the standards set in the Building (Scotland) Regulations 2004 and are available in two volumes; for Domestic buildings and for Non-domestic buildings.
26. *Building (Scotland) Regulations 2004*: The Stationery Office (TSO)
27. *BS 5906: 2005 – Waste management in buildings*: British Standard 2005
28. *Sewers for Scotland*: Scottish Water (second edition) 2007
29. *Sewerage (Scotland) Act 1968*: The Stationery Office (TSO)
30. *The SUDS Manual*: CIRIA 2007
31. *Planning Advice Note (PAN) 61: Planning and Sustainable Urban Drainage*: Scottish Executive 2001
32. *Water Environment and Water Services (Scotland) Act 2003 (WEWS Act 2003)*
33. *Water Framework Directive*: The European Water Framework Directive came into force in December 2000 and became part of UK law in December 2003.
34. *Water Environment (Controlled Activities) (Scotland) Regulations 2005 (CAR)4*:
35. *Flood Risk Management (Scotland) Act 2009*: The Stationery Office (TSO)
36. *Drainage Assessment – A Guide for Scotland*: Scottish Environmental Protection Agency/SUDS Working Party 2005
37. *SUDS for Roads*: SUDS Working Party (authored WSP) 2009
38. *Volume 2: NJUG Guidelines On The Positioning Of Underground Utilities Apparatus For New Development Sites (Issue 3)*: National Joint Utilities Group 2007
39. *Tree Roots in the Built Environment*: Department for Communities and Local Government 2006
40. *Roads (Scotland) Act 1984*: The Stationery Office (TSO)
41. *The Traffic Signs Regulations and General Directions*: The Stationery Office (TSO) 2002
42. *Traffic Signs Manual*: Department for Transport 2006
43. *BS 8300 – Design of buildings and their approaches to meet the needs of disabled people*: British Standard 2009
44. *BS EN 13201-2:2003*: Road lighting. Performance requirements 2003
45. *BS EN 13201-3:2003*: Road lighting. Part 3: Calculation of performance 2003
46. *BS EN 13201-4:2003*: Road lighting. Methods of measuring lighting performance 2003
47. *BS 5489-1:2003+A2:2008: Code of Practice for the Design of Road Lighting. Lighting of Roads and Public Amenity Areas (Amended 2008)*
48. *Controlling Light Pollution and Reducing Lighting Energy Consumption*: Scottish Government (Web only from [www.scotland.gov.uk](http://www.scotland.gov.uk)) 2007
49. *Planning Advice Note (PAN) 51*: Planning, Environmental Protection and Regulation (Revised 2006)
50. *Highway Risk and Liability Claims*: UK Roads Board and the Institution of Civil Engineers (ICE) 2009
51. *Scotland Act 1998*: The Stationery Office (TSO)
52. *Road Traffic Act 1988*: The Stationery Office (TSO)
53. *Statutory Code of Practice on the Disability Equality Duty (England and Wales) 2005*: The Disability Rights Commission (DRC)

## Acknowledgments

*Designing Streets* was produced by a multidisciplinary team led by WSP UK.

### Core Team

Elaine Barrie (WSP)  
Andrew Cameron (WSP)  
Karen Esslemont (EDAW)  
Keith Gowenlock – Project Director (WSP)  
Colin Innes (Shepherd and Wedderburn LLP)  
Phil Jones (Phil Jones Associates)  
Neil McDonald (WSP)  
David Nicol (WSP)  
Chris Pittner (WSP)  
Alan Young (WSP)

### Steering Group

Mic Ralph – SCOTS (Glasgow City Council)  
Stuart D'all – SCOTS (Perth and Kinross Council)  
Paul Ince – SCOTS (East Lothian Council)  
Neil McLean – SEPA

### Images Supplied by

ATKINS  
Cadell2 LLP  
City of Edinburgh Council  
Dougie Barnett Photography  
EDAW (AECOM)  
Gillespies  
HTA  
John Cooper Photography  
John Thomson & Partners  
Karen Esslement  
Keith Hunter Photography  
Land Use Consultants  
Living Streets  
Malcolm Fraser Architects  
Parc Craigmillar  
Paul Zanre Photography  
Phil Jones Associates  
WSP



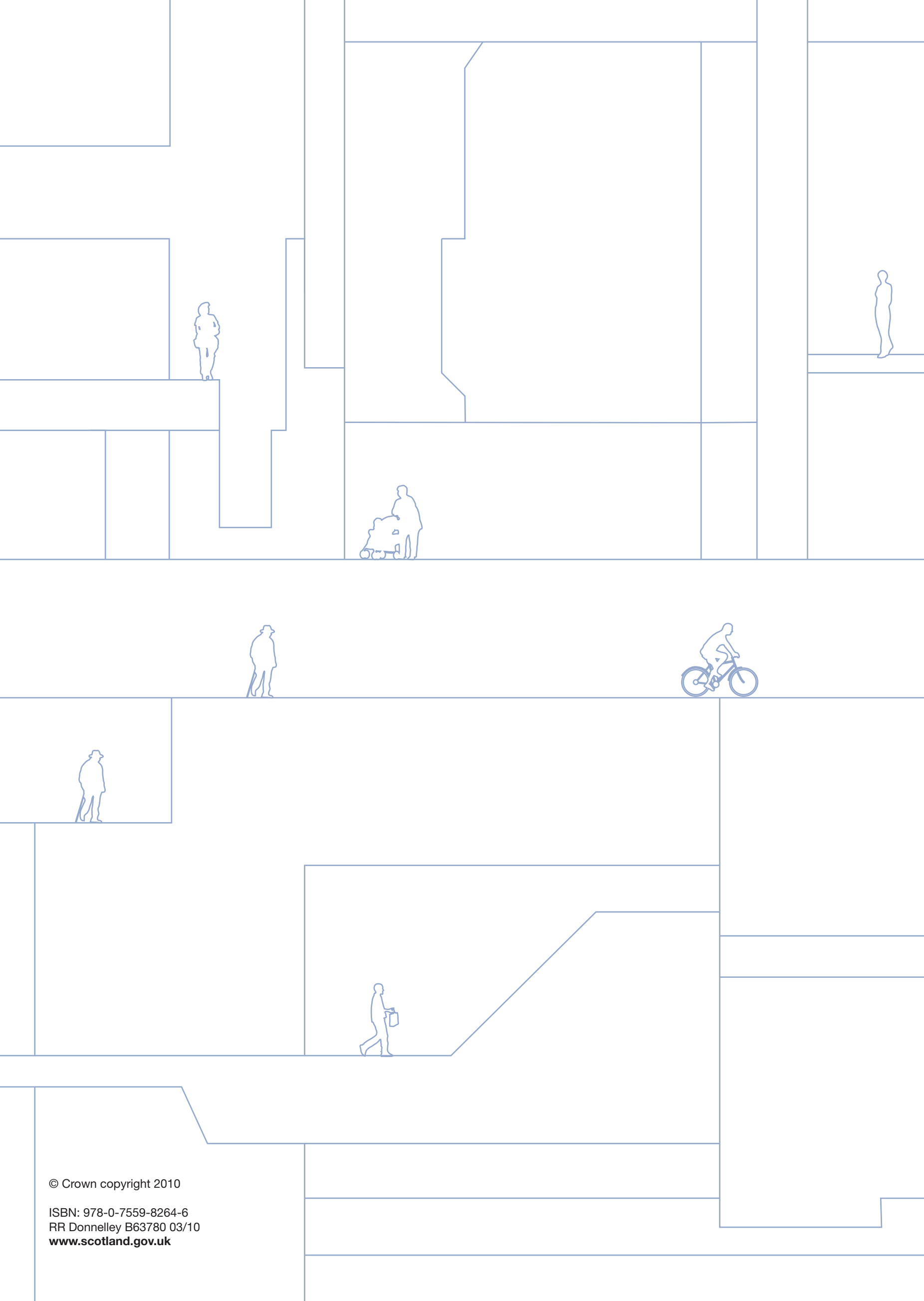

© Crown copyright 2010

ISBN: 978-0-7559-8264-6  
RR Donnelley B63780 03/10  
[www.scotland.gov.uk](http://www.scotland.gov.uk)